

# Catalogue Lighting Novembre 2019



# **SOGUADIME**

LE MATÉRIEL ÉLECTRIQUE

**A Sonepar Company**



## Table des matières

FONCTIONNEL

4

EXTÉRIEUR ET JARDIN

31

LES ENCASTRÉS

54

SUSPENSIONS, LAMPADAIRES  
ET LAMPES À POSER

59

APPLIQUES ET PLAFONNIERS

76

SALLE DE BAIN

91

RUBANS LEDS

98

SOLAIRE

103

ACCESSOIRES

110

LAMPES

114

ÉCLAIRAGE PUBLIC

132



**SOGUADIME**

LE MATÉRIEL ÉLECTRIQUE



# HUBLOTS

## PLAFONNIER / APPLIQUE MURALE OPALE RONDE



Référence	Désignation	Prix public € H.T.	Prix promo € H.T.	CODE EAN
TRI7143440	2340 WD2 LED 22/14/08/ML-840 E	45,60 €	30,00 €	4 018242 413683

## HUBLOT ROND TOM LED 300 1200 840 WH



Référence	Désignation	Prix public € H.T.	Prix promo € H.T.	CODE EAN
THO96666080	HUBLOT ROND TOM LED 300 1200 840 WH	66,60 €	24,00 €	9 008709 914056

## HUBLOT / PLAFONNIER EXTÉRIEUR LED



Référence	Désignation	Prix public € H.T.	Prix promo € H.T.	CODE EAN
EBE078220	OPTION AV 1200LM 15W 4000K BLANC	144,90 €	73,00 €	3 477870 782201

## HUBLOTS

### HUBLOT AVEC SYSTÈME LED - LIMARO



Référence	Désignation	Prix public € H.T.	Prix promo € H.T.	CODE EAN
TRI6964340	LIMARO WD1 1000-840 ET	46,00 €	30,00 €	4 018242 384068
TRI6964740	LIMARO WD2 1400-840 ET	48,00 €	32,00 €	4 018242 384082
TRI6965140	LIMARO WD2 2000-840 ET	60,00 €	39,00 €	4 018242 384105
TRI6964840	LIMARO WD2 1400-840 ET + HFS	68,00 €	45,00 €	4 018242 384099
TRI6965240	LIMARO WD2 2000-840 ET + HFS	84,00 €	55,00 €	4 018242 384112

### HUBLOT LED POLYCARBONATE OVALE



Référence	Désignation	Prix public € H.T.	Prix promo € H.T.	CODE EAN
AURENBH21540	HUBLOT OVALE LED UTILITE 15W	34,15 €	19,00 €	5 055155 498948

# HUBLOTS

## HUBLOT LED POLYCARBONATE ROND



Référence	Désignation	Prix public € H.T.	Prix promo € H.T.	CODE EAN
AURENBH25W40	HUBLOT LED ORBITAL IP66 IK10 2	78,70 €	35,00 €	5 055155 403409

## HUBLOT LED À DÉTECTEUR 6500K



Référence	Désignation	Prix public € H.T.	Prix promo € H.T.	CODE EAN
GEL93073529	HUBLOT LED 6500K 855LM	50,25 €	33,00 €	1 006489 457907
GEL93073545	HUBLOT LED 6500K 2400LM	76,50 €	47,00 €	1 006489 457914
GEL93073548	HUBLOT LED À DÉTECTEUR 6500K	96,00 €	56,00 €	1 006489 457921

## HUBLOT LED 4200K IP54



Référence	Désignation	Prix public € H.T.	Prix promo € H.T.	CODE EAN
LUM7271442S	HUBLOT LED 14W D270 4200K IP54	84,00 €	39,00 €	3 700005 373976



## HUBLOTS

## HUBLOT LED 4200K IP54



Référence	Désignation	Prix public € H.T.	Prix promo € H.T.	CODE EAN
LUM7363042S	HUBLOT LED 30W D360 4200K IP54	106,00 €	39,00 €	3 700005 373556

## HUBLOT LED IP54



COULEUR INTERCHANGEABLE  
3000K - 4000K - 6000K



Référence	Désignation	Prix public € H.T.	Prix promo € H.T.	CODE EAN
LUM72015346KBD	HUBLOT LED 15W D200 IP54	84,00 €	37,00 €	3 700005 372016
LUM73030346KBD	HUBLOT LED 30W D300 IP54	106,00 €	44,00 €	3 700005 373037

## PLAFONNIER ÉTANCHE ROND AVEC VASQUE PC OPALE CULOT E 27



Référence	Désignation	Prix public € H.T.	Prix promo € H.T.	CODE EAN
TRI1717610	DISCUS/1 E27	26,00 €	17,00 €	8 019163 103390



## LES ENCASTRÉS

### DOWNLIGHT LED ROND 4000K



Référence	Désignation	Prix public € H.T.	Prix promo € H.T.	CODE EAN
LUM3612US42B	DOWNLIGHT 12W 960LM 4000K	35,00 €	12,00 €	3 700005 336131
LUM362440B	DOWNLIGHT 24W 1920LM 4000K	45,00 €	20,00 €	3 700005 336247

### LED'UP ÉCO SLIM ROND



Référence	Désignation	Prix public € H.T.	Prix promo € H.T.	CODE EAN
EUR453031	DOWNLIGHT SLIM 7W 4000K IP44	29,35 €	13,00 €	9 000100 000574

### DOWNLIGHT LED ORIENTABLE APEX



Référence	Désignation	Prix public € H.T.	Prix promo € H.T.	CODE EAN
AURENRSP32440	DOWNLIGHT LED ORIENTABLE APEX	97,50 €	59,00 €	5 056102 012965



## LES ENCASTRÉS

## RS061B LED5-36-/840 PSR II WH



Référence	Désignation	Prix public € H.T.	Prix promo € H.T.	CODE EAN
PHI072707	RS061B LED5-36-/840 PSR II WH	24,75 €	15,00 €	8 718696 072707
PHI072691	RS061B LED5-36-/830 PSR II WH	24,75 €	15,00 €	8 718696 072691

## DOWNLIGHT LED RECTANGLE INCLINABLE



Référence	Désignation	Prix public € H.T.	Prix promo € H.T.	CODE EAN
LUM861B	DOWNLIGHT LED RECTANGULAIRE INCLINABLE 30W LED 3000LM 842	119,70 €	49,00 €	3 700005 308619

## DN065B LED10S/840 PSU II WH



Référence	Désignation	Prix public € H.T.	Prix promo € H.T.	CODE EAN
PHI381769	DN065B LED10S/840 PSU II WH	37,50 €	21,00 €	8 718699 381769
PHI381783	DN065B LED20S/840 PSU II WH	40,00 €	24,00 €	8 718699 381783

# LES ENCASTRÉS

DN060B LED18S/840 PSU WH



Référence	Désignation	Prix public € H.T.	Prix promo € H.T.	CODE EAN
PHI306636	DN060B LED18S/840 PSU WH	42,50 €	26,00 €	8 710163 306636

2320 C07 WR LED 20/12/ML-840 E



Référence	Désignation	Prix public € H.T.	Prix promo € H.T.	CODE EAN
TRI7143040	2320 C07 WR LED 20/12/ML-840 E	40,80 €	29,00 €	4 018242 402649

2325 C07 OA LED 18/10/ML-840 E



Référence	Désignation	Prix public € H.T.	Prix promo € H.T.	CODE EAN
TRI7143140	2325 C07 OA LED 18/10/ML-840 E	33,36 €	22,00 €	4 018242 402656



## LES ENCASTRÉS

### SNCPOINT 905 C02 BR-FL LED1100



Référence	Désignation	Prix public € H.T.	Prix promo € H.T.	CODE EAN
TRI6528740	SNCPOINT 905 C02 BR-FL LED1100	68,00 €	42,50 €	4 018242 333417

### GRACE ENCASTRÉ IP20/44 LED INTÉGRÉ 7W/3000K



Référence	Désignation	Prix public € H.T.	Prix promo € H.T.	CODE EAN
ARI50331	GRACE BLC LED 7W/3000K	23,20 €	11,00 €	3 170070 503316
ARI50333	GRACE BLC LED 7W/4000K	23,20 €	12,00 €	3 170070 503330

### SPOT ENCASTRÉ - AMBIELLA G2 C07 HR LED2000-840



Référence	Désignation	Prix public € H.T.	Prix promo € H.T.	CODE EAN
TRI6913740	AMBIELLA G2 C07 HR LED1300-840	58,00 €	38,00 €	4 018242 377268
TRI6854640	AMBIELLA G2 C07 HR LED2000-840	66,00 €	43,00 €	4 018242 367986

# LES ENCASTRÉS

## DOWNLIGHT ENCASTRÉ LED - AVIELLA C05 OA 1200-840 ET 1



Référence	Désignation	Prix public € H.T.	Prix promo € H.T.	CODE EAN
TRI6864740	AVIELLA C05 OA 1200-840 ET 01	41,00 €	27,00 €	4 018242 369485
TRI6864940	AVIELLA C07 OA 2000-840 ET 01	46,00 €	30,00 €	4 018242 369522

## SPOT ROND À ENCATRER ROND



new

COULEUR  
INTERCHANGEABLE  
4000K





Référence	Désignation	Prix public € H.T.	Prix promo € H.T.	CODE EAN
LUM3607	ENCASTRÉ ROND 7W 650LM DIM	25,00 €	15,00 €	3 700005 336070
LUM3610	ENCASTRÉ ROND 10W 950LM DIM	30,00 €	19,00 €	3 700005 336100
LUM3617	DOWNLIGHT 17W 1650LM 4000K	35,00 €	22,00 €	3 700005 336179
LUM3625	DOWNLIGHT 25W 2450LM 4000K	40,00 €	27,00 €	9 000100 000598



## LUMINAIRES FONCTIONNELS

## PANNEAU LEDINAIRE LED



Référence	Désignation	Prix public € H.T.	Prix promo € H.T.	CODE EAN
PHI791803	RC065B LED34S/840 PSU W60L60 N	57,50 €	35,00 €	 8 718699 791803
PHI073285	RC065B LED32S/840 PSU W60L60 N	56,12 €	39,00 €	 8 718696 073285

## ENCATRÉ LED 600x600



Référence	Désignation	Prix public € H.T.	Prix promo € H.T.	CODE EAN
TRI7165740	ENCATRÉ LED 600x600, DIFFUSEUR OPALE UGR 19. 4000K	52,80 €	35,00 €	 4 018242 421367

## SIELLA II M73 OTA LED3200-840



Référence	Désignation	Prix public € H.T.	Prix promo € H.T.	CODE EAN
TRI7100000	CADRE SAILLIE SIELLA G4/G5	46,00 €	30,00 €	 4 018242 400379
TRI7164440	SIELLA G5 M73 OTA22 LED3600-84	53,00 €	36,00 €	 4 018242 421008

## LUMINAIRES FONCTIONNELS

### SIELLA II M73 OTA LED3200-840



Référence	Désignation	Prix public € H.T.	Prix promo € H.T.	CODE EAN
TRI7165040	SIELLA G5 M73 OTA19 LED3600-84	62,00 €	41,00 €	 4 018242 421121
TRI7165051	SIELLA G5 M73 OTA19 LED3600-84	99,00 €	65,00 €	 4 018242 421145

### DALLE LED 36W 6000K V2



Référence	Désignation	Prix public € H.T.	Prix promo € H.T.	CODE EAN
LUM4108	CADRE SAILLIE POUR LED 6X6	46,00 €	29,00 €	 3 700005 341081
LUM4103	DALLE LED 36W 6000K V2	70,00 €	35,00 €	 3 700005 301894

### CADRE SAILLIE SMB W60L60



Référence	Désignation	Prix public € H.T.	Prix promo € H.T.	CODE EAN
PHI073308	RC125Z CADRE SAILLIE SMB W60L60	38,65 €	27,00 €	 8 718696 073308



# LUMINAIRES FONCTIONNELS

## DALLE LED ENCASTRÉE 600X600

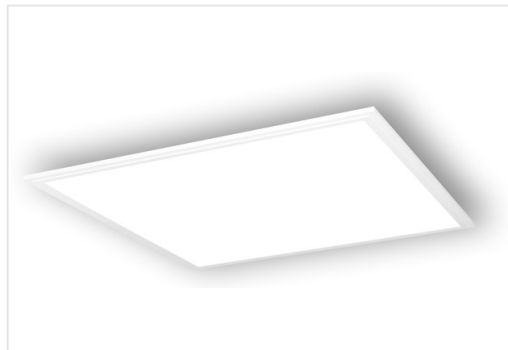

Référence	Désignation	Prix public € H.T.	Prix promo € H.T.	CODE EAN
GEL93073980	DALLE LED 600 860 36W UGR19	54,90 €	35,00 €	9 000100 000581

## PLAFONNIERS À LED



Référence	Désignation	Prix public € H.T.	Prix promo € H.T.	CODE EAN
PHI069622	LEDINAIRE SAILLIE LED34S/840	100,00 €	58,00 €	8 718696 069622
TRI7165440	SIELLA G5 1200X300 ENCASTRÉ	144,00 €	96,00 €	4 018242 421206
TRI7142840	2350 D2 OTA19 40/30/ML-840 ET	151,68 €	101,00 €	4 018242 402625
TRI6742940	SIELLA G3 ENCAST. 120X30	160,00 €	104,00 €	4 018242 352616
TRI6914840	SIELLA G3 SAILLIE 120X30	180,00 €	124,00 €	4 018242 377404
TRI6914851	SIELLA D2 OTA19 LED3400-840 ET	331,35 €	124,00 €	4 018242 377411



# LUMINAIRES FONCTIONNELS

## PLAFONNIERS À LAMPES FLUORESCENTES



**DESTOCKAGE**

new

FONCTIONNEL

Référence	Désignation	Prix public € H.T.	Prix promo € H.T.	CODE EAN
TRI5289504	AVESTO D RWV 236 E	66,00 €	43,00 €	 4 018242 196333
TRI5311000	AVESTO ZWF	66,00 €	43,00 €	 4 018242 201891
TRI6316804	AVESTO D RAV 149 E	90,00 €	59,00 €	 4 018242 315987
TRI6314604	AVESTO D RPV 228 E	94,00 €	38,00 €	 4 018242 316069
TRI6315004	AVESTO D RPV 249 E	110,00 €	72,00 €	 4 018242 316106
TRI6315104	AVESTO D RPV 414 E	116,00 €	76,00 €	 4 018242 316120
TRI6472540	PLAFONNIER STANDARD LED L:1200	160,00 €	104,00 €	 9 000005 000006



## ÉTANCHES

PLAFONNIER POUR LOCAUX HUMIDES ET EXTÉRIEUR SOUS ABRI



Référence	Désignation	Prix public € H.T.	Prix promo € H.T.	CODE EAN
TRI7115640	2315 1200 4000-840 ET PC	51,20 €	34,00 €	 4 018242 402700
TRI7115840	2315 1500 6000-840 ET PC	59,40 €	39,00 €	 4 018242 402724

LED MARINER ST G1 TU 2' 24W 865 S EU



Référence	Désignation	Prix public € H.T.	Prix promo € H.T.	CODE EAN
GEL93090164	LED MAR ST GEN1 GE 2FT 24W 865	36,60 €	29,00 €	 1 006489 459475

LEDINAIRE WT060C ÉTANCHE



Référence	Désignation	Prix public € H.T.	Prix promo € H.T.	CODE EAN
PHI389123	WT060C LED36S/840 PSU L1201	65,00 €	42,00 €	 8 718699 389123
PHI389147	WT060C LED56S/840 PSU L1500	75,00 €	45,00 €	 8 718699 389147

# ÉTANCHES

## LUMINAIRE ÉTANCHE À LED - NEXTREMA



Référence	Désignation	Prix public € H.T.	Prix promo € H.T.	CODE EAN
TRI6631640	NEXTREMA G3 B 6000-840 ET PC	312,00 €	208,00 €	4 018242 346806

## LUMINAIRES TUBULAIRES AU DIAMÈTRE EXTÉRIEUR



Référence	Désignation	Prix public € H.T.	Prix promo € H.T.	CODE EAN
TRI6190904	STILO 70 149 PC E	160,00 €	80,00 €	9 0001 00 000604
TRI6317240	STILO 100 LED4800-840 ET L1550	150,00 €	149,00 €	9 0001 00 000604

## ÉTANCHE LED IP66 5000H COMPLETS



Référence	Désignation	Prix public € H.T.	Prix promo € H.T.	CODE EAN
TRI6797440	OLEXEON 1200 B 4000-840 ET PC	94,00 €	62,00 €	4 018242 359219
TRI6797640	OLEXEON 1500 B 4000-840 ET PC	159,10 €	132,00 €	4 018242 359233

## ÉTANCHES

## PLAFONNIER ÉTANCHE AVEC LED MID POWER



Référence	Désignation	Prix public € H.T.	Prix promo € H.T.	CODE EAN
GEWGWS3236PC	SMART3 COMPACT 800 OPALE 30W	105,30 €	58,00 €	8 011564 886995
GEWGWS3258PC	SMART3 COMPACT 1200 OPALE 50W	121,50 €	67,00 €	8 011564 887015

## PLAFONNIER ET APPLIQUE MURALE POUR APPLICATION STANDARD



Référence	Désignation	Prix public € H.T.	Prix promo € H.T.	CODE EAN
TRI5287504	OLEVEON 249 PC E	32,30 €	23,00 €	4 018242 197989
TRI5218904	OLEVEON 118 PC E	46,00 €	30,00 €	4 018242 196876
TRI5219504	OLEVEON 136 PC E	48,00 €	32,00 €	4 018242 196982
TRI5220404	OLEVEON 218 PC E	52,00 €	21,00 €	4 018242 197200
TRI5221004	OLEVEON 236 PC E	54,00 €	36,00 €	4 018242 197262
TRI5219804	OLEVEON 158 PC E	54,00 €	36,00 €	4 018242 197071
TRI5221304	OLEVEON 258 PC E	54,00 €	36,00 €	4 018242 197354
TRI5287304	OLEVEON 254 PC E	118,75 €	21,00 €	4 018242 197965
TRI5827504	OLEVEON 149 PC E	32,30 €	21,00 €	8 428879 004523
TRI5640304	OLEVEON 1-235 PC E	32,30 €	21,00 €	4 018242 208838

# RÉGLETTES INTÉRIEURES

## RÉGLETTES À MONTAGE APPRENT LED



Référence	Désignation	Prix public € H.T.	Prix promo € H.T.	CODE EAN
TRI6486340	RIDOSS LED1000-830 ET	42,00 €	28,00 €	4 018242 328949
TRI6486240	RIDOSS LED1000-840 ET	42,00 €	28,00 €	4 018242 328932
TRI6486540	RIDOSS LED1600-830 ET	76,00 €	50,00 €	4 018242 328963
TRI6486440	RIDOSS LED1600-840 ET	76,00 €	50,00 €	4 018242 328956

## RÉGLETTES À MONTAGE APPRENT POUR 1 LAMPE FLUORESCENTE



Référence	Désignation	Prix public € H.T.	Prix promo € H.T.	CODE EAN
TRI5795204	RIDOS 40 118 E	45,50 €	19,00 €	4 018242 240050
TRI5797204	RIDOS 40 136 E	47,05 €	20,00 €	4 018242 240104

## RÉGLETTES INTÉRIEURES

### RÉGLETTE LEDINAIRE BN060C



Référence	Désignation	Prix public € H.T.	Prix promo € H.T.	CODE EAN
PHI070079	BN060C 1XTLED16/840 REGLETTE	46,36 €	29,00 €	8 718696 070079

### RÉGLETTE PENTURA MINI LED





Référence	Désignation	Prix public € H.T.	Prix promo € H.T.	CODE EAN
PHI072431	BN132C LED12S/840 PSU L1200	35,50 €	22,00 €	8 718696 072431
PHI072455	BN132C LED9S/840 PSU L900	36,60 €	23,00 €	8 718696 072455

# SUSPENSIONS INDUSTRIELLES

## 2380 ARMATURE INDUSTRIELLE



Référence	Désignation	Prix public € H.T.	Prix promo € H.T.	CODE EAN
<b>TRI7143340</b>	2380 ARMATURE INDUSTRIELLE 20000 LM TB 20000-840 ET	<b>319,20 €</b>	<b>212,00 €</b>	 4 018242 413676
<b>TRI7143240</b>	2380 ARMATURE INDUSTRIELLE 30000 LM TB 30000-840 ET	<b>403,20 €</b>	<b>269,00 €</b>	 4 018242 413669

## ARMATURE INDUSTRIELLE LED POUR MONTAGE SUSPENDU



Référence	Désignation	Prix public € H.T.	Prix promo € H.T.	CODE EAN
<b>TRI6574840</b>	ONDO TB LED 10000-840 ET 03	<b>360,00 €</b>	<b>234,00 €</b>	 4 018242 337675
<b>TRI6575040</b>	ONDO TB LED 20000-840 ET 03	<b>480,00 €</b>	<b>312,00 €</b>	 4 018242 337699

## LIGNES LUMINEUSES

### PLATINE-APPAREILLAGE LED POUR SYSTÈME DE LIGNE CONTINUE C-L



Référence	Désignation	Prix public € H.T.	Prix promo € H.T.	CODE EAN
TRI6461340	7640B LED8000-840 ET	210,00 €	124,00 €	4 018242 325290

### PROFITS - SUPPORTS POUR L'ÉCLAIRAGE INDUSTRIEL



Référence	Désignation	Prix public € H.T.	Prix promo € H.T.	CODE EAN
TRI6470500	07640/I/5LV/E-2 5	32,00 €	21,00 €	4 018242 325108
TRI6470800	07640/II/5LV-2 5	50,00 €	33,00 €	4 018242 325139

### PLAQUE DE RECOUVREMENT À MONTAGE RAPIDE C-LINE LED



Référence	Désignation	Prix public € H.T.	Prix promo € H.T.	CODE EAN
TRI6471900	PLAQUE DE RECOUVREMENT À MONTAGE RAPIDE C-LINE LED - 07640B L1720	9,30 €	9,00 €	4 018242 327157



# LIGNES LUMINEUSES

## CONNECTEUR MÂLE ET FEMELLE À 7 PÔLES



Référence	Désignation	Prix public € H.T.	Prix promo € H.T.	CODE EAN
TRI2197300	CONNECTEUR MÂLE ET FEMELLE À 7 PÔLES POUR RACCORD ÉLECTRIQUE DE FILERIES TRANVERSANTES - 07690 VV	7,60 €	4,00 €	4 018242 069842

## CRAMPON DE SUSPENSION POUR MONTAGE PAR CHÂÎNE



Référence	Désignation	Prix public € H.T.	Prix promo € H.T.	CODE EAN
TRI2342800	E 03 KX	2,00 €	2,00 €	4 018242 036844

## EMBOUT FRONTAL IP20





Référence	Désignation	Prix public € H.T.	Prix promo € H.T.	CODE EAN
TRI2194700	EMBOUT FRONTAL IP20 - 07690 E-R	1,00 €	1,00 €	4 018242 070763

## RAILS

## RAIL D'ÉCLAIRAGE TRIPHASÉ SAIL



Référence	Désignation	Prix public € H.T.	Prix promo € H.T.	CODE EAN
AURMLXTS420N	RAIL D'ÉCLAIRAGE TRIPHASÉ SAIL	80,75 €	49,00 €	 3 609640 134372
AURMLXTS430N	RAIL D'ÉCLAIRAGE TRIPHASÉ SAIL	121,25 €	73,00 €	 3 609640 134396

## SPOT SUPROS POUR RAIL TRIPHASÉ



Référence	Désignation	Prix public € H.T.	Prix promo € H.T.	CODE EAN
SLV152810	SUPROS TRACK 3000 NOIR 4000K	329,40 €	215,00 €	 4 024163 166799

## PROJECTEUR ALUMINIUM LED TRIPH



Référence	Désignation	Prix public € H.T.	Prix promo € H.T.	CODE EAN
AURENKT3536BLK40	PROJECTEUR ALUMINIUM LED TRIPH	122,50 €	74,00 €	 5 056102 015003

# RAILS

## SUPPORT DE FIXATION NOIR POUR RAIL



Référence	Désignation	Prix public € H.T.	Prix promo € H.T.	CODE EAN
AURMLSKB12N	SUPPORT DE FIXATION NOIR POUR	7,20 €	3,00 €	 3 609640 134297

## RACCORD DROIT POUR RAIL TRIPHASÉ



Référence	Désignation	Prix public € H.T.	Prix promo € H.T.	CODE EAN
AURMLXTSA21N	RACCORD DROIT POUR RAIL TRIPHASÉ	15,00 €	9,00 €	 3 609640 134471

## EMBOUT D'ALIMENTATION GAUCHE



Référence	Désignation	Prix public € H.T.	Prix promo € H.T.	CODE EAN
AURMLXTSA11N	EMBOUT D'ALIMENTATION GAUCHE P	19,25 €	12,00 €	 3 609640 134419

## RAILS



## RACCORD EN L (EXTÉRIEUR)



Référence	Désignation	Prix public € H.T.	Prix promo € H.T.	CODE EAN
AURMLXTSA35N	RACCORD EN L (EXTÉRIEUR) POUR	54,50 €	33,00 €	 3 609640 134556

## RACCORD EN T (EXTÉRIEUR DROIT ET GAUCHE)



Référence	Désignation	Prix public € H.T.	Prix promo € H.T.	CODE EAN
AURMLXTSA36N	RACCORD EN T (EXTÉRIEUR DROIT)	76,25 €	46,00 €	 3 609640 134570
AURMLXTSA39N	RACCORD EN T (EXTÉRIEUR GAUCHE)	76,25 €	46,00 €	 3 609640 134631

## RACCORD EN X POUR RAIL TRIPHASÉ



Référence	Désignation	Prix public € H.T.	Prix promo € H.T.	CODE EAN
AURMLXTSA38N	RACCORD EN X POUR RAIL TRIPHASÉ	93,75 €	57,00 €	 3 609640 134617

# RAILS

## EMBOUT DE FINITION POUR RAIL T



Référence	Désignation	Prix public € H.T.	Prix promo € H.T.	CODE EAN
AURMLXSA41N	EMBOUT DE FINITION POUR RAIL T	3,50 €	3,00 €	3 609640 134679

## RAIL EN SAILLIE TROIS ALLUMAGES 230V 2M



Référence	Désignation	Prix public € H.T.	Prix promo € H.T.	CODE EAN
SLV175024	S-TRACK RAIL 3ALL GRIS-ARGENT 2M	87,75 €	47,00 €	4 024163 161206

## SUPPORT DE SUSPENSION ALUMINIUM



Référence	Désignation	Prix public € H.T.	Prix promo € H.T.	CODE EAN
AURMLSKB16A	SUPPORT DE SUSPENSION ALUMINIUM	4,25 €	3,00 €	3 609640 134310

## RAILS

## ADAPTATEUR TRIPHASÉ POUR RAIL EN SAILLIE TRIPHASÉ 230V



Référence	Désignation	Prix public € H.T.	Prix promo € H.T.	CODE EAN
SLV175204	S-TRACK ADAPTATEUR ÉLEC. GRIS-ARGENT	21,85 €	12,00 €	4 0241 63 161763

## ALIMENTATION POUR RAIL EN SAILLIE TRIPHASÉ 230V



Référence	Désignation	Prix public € H.T.	Prix promo € H.T.	CODE EAN
SLV175044	S-TRACK ALIM GRIS-ARGENT TERRE GAUC	21,85 €	12,00 €	4 0241 63 161268

## CONNECTEUR LONGITUDINAL POUR RAIL EN SAILLIE TRIPHASÉ 230V



Référence	Désignation	Prix public € H.T.	Prix promo € H.T.	CODE EAN
SLV175074	S-TRACK MINI-CONNECTEUR GRIS-ARGENT	16,35 €	9,00 €	4 0241 63 161350

## RAILS

### EMBOUT POUR RAIL EN SAILLIE TRIPHASÉ 230V



Référence	Désignation	Prix public € H.T.	Prix promo € H.T.	CODE EAN
SLV175064	S-TRACK EMBOUT GRIS ARGENT	4,40 €	3,00 €	4 0241 63 161329

### FILIN DE SUSPENSION POUR RAIL EN SAILLIE TRIPHASÉ 230V



Référence	Désignation	Prix public € H.T.	Prix promo € H.T.	CODE EAN
SLV175170	S-TRACK KIT SUSP. 5M NOIR	43,80 €	29,00 €	4 0241 63 161657





## PROJECTEURS



### BVP650 LTX ECO 29000/NW PSU II

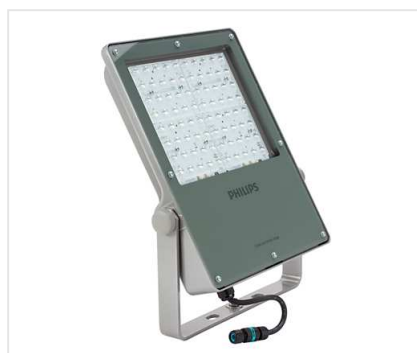

Référence	Désignation	Prix public € H.T.	Prix promo € H.T.	CODE EAN
<b>PHIBVP650</b>	BVP650 LTX ECO 29000/NW PSU II	<b>1939,80 €</b>	<b>920,00 €</b>	 1 174128 940001

### CORELINE TEMPO MOYEN ET GRAND



Référence	Désignation	Prix public € H.T.	Prix promo € H.T.	CODE EAN
<b>PHI455873</b>	BVP125 LED120-4S/740 A	<b>475,80 €</b>	<b>310,00 €</b>	 8 718699 455873
<b>PHI096403</b>	BVP130 LED210/740 A	<b>729,56 €</b>	<b>475,00 €</b>	 8 718699 096403

### CLEARFLOOD LARGE



Référence	Désignation	Prix public € H.T.	Prix promo € H.T.	CODE EAN
<b>PHI112820</b>	BVP651 LED750-4S/740 OFA52 ALU	<b>3096,85 €</b>	<b>2013,00 €</b>	 8 718699 112820

## PROJECTEURS

## BVP154 LED PSU VWB C



Référence	Désignation	Prix public € H.T.	Prix promo € H.T.	CODE EAN
PHI329710	BVP154 LED10/840 PSU 10W VWB C	23,75 €	15,00 €	8 710163 329710
PHI329734	BVP154 LED21/840 PSU 20W VWB C	48,75 €	29,00 €	8 710163 329734
PHI329758	BVP154 LED52/840 PSU 50W VWB C	97,50 €	59,00 €	8 710163 329758

## BVP154 &amp; BVP155 LED PSU



Référence	Désignation	Prix public € H.T.	Prix promo € H.T.	CODE EAN
PHI331348	BVP154 LED21/840 PSU 20W VWB M	81,25 €	48,00 €	8 710163 331348
PHI331362	BVP154 LED52/840 PSU 50W VWB M	155,50 €	89,00 €	8 710163 331362
PHI331294	BVP155 LED150/840 PSU 150W AWB	344,20 €	135,00 €	8 710163 331294
PHI331300	BVP155 LED200/840 PSU 200W AWB	446,90 €	270,00 €	8 710163 331300

# PROJECTEURS

## PROJECTEURS LED - GÉNÉRAL ÉLECTRIC



Référence	Désignation	Prix public € H.T.	Prix promo € H.T.	CODE EAN
GEL93082101	PROJECTEUR LED 20W 6500K	34,89 €	23,00 €	1 006489 458737
GEL93082102	PROJECTEUR LED 30W 6500K	52,32 €	34,00 €	9 000100 000581
GEL93082103	PROJECTEUR LED 50W 6500K	64,53 €	42,00 €	1 006489 458744
GEL93082106	PROJECTEUR LED 20000LM 150W 6500K	345,00 €	205,00 €	1 006489 458744
GEL93101684	PROJECTEUR LED 18000LM 150W 4000K AS	360,00 €	209,00 €	9 000100 000611

## PROJECTEUR LED - LUMINIS



Référence	Désignation	Prix public € H.T.	Prix promo € H.T.	CODE EAN
LUM940	PROJECTEUR LED 10W 900LM 4200	42,50 €	15,00 €	3 700005 309401
LUM941	PROJECTEUR LED 20W 2000LM 4200	65,00 €	25,00 €	3 700005 309418
LUM942	PROJECTEUR LED 30W 3000LM 4200	90,00 €	39,00 €	3 700005 309425
LUM963	PROJECTEUR LED 50W 4500LM 4200	90,00 €	59,00 €	3 700005 309425
LUM943	PROJECTEUR LED 50W 4500LM 4200	110,00 €	49,00 €	3 700005 309432



## PROJECTEURS





## PROJECTEUR LED POUR ILLUMINATION ET ÉCLAIRAGE DE SURFACES



Référence	Désignation	Prix public € H.T.	Prix promo € H.T.	CODE EAN
TRI6960040	COMBIAL 30-RB8R/7500-740 1G1W	294,00 €	234,00 €	 4 018242 380596
TRI7076640	COMBIAL 40-AM9R/12000-740 1G1W	384,00 €	290,00 €	 4 018242 400072
TRI6960140	COMBIAL 40-RB8R/12000-740 1G1W	384,00 €	299,00 €	 4 018242 380602

## PROJECTEURS LED HAUTE PUISSANCE



Référence	Désignation	Prix public € H.T.	Prix promo € H.T.	CODE EAN
GEWGWS4134GS	SMART[4] FL 5L ST.AL.4000K DI.	267,30 €	147,00 €	 8 011564 867772
GEWGWS4046GS	SMART[4] HB 4+4L ST.AL.4000K A	668,51 €	314,00 €	 8 011564 867277
GEWGWS4064GS	SMART[4] HB 4X4L ST.AL.4000K D	1269,17 €	564,00 €	 8 011564 867802
GEWGWS4066GS	SMART[4] HB 4X4L ST.AL.4000K A	1269,17 €	659,00 €	 8 011564 867918

# PROJECTEURS

## KIT ÉTRIER



Référence	Désignation	Prix public € H.T.	Prix promo € H.T.	CODE EAN
GEWGWL1924	SMART [4] HB 4+4-5+5L WALL BRA	42,72 €	21,00 €	8 011564 816794
GEWGWL1925	SMART [4] HB 4X4-5X5L WALL BRA	201,06 €	98,00 €	8 011564 816800

## PROJECTEUR ELFI BLC 60 10W/4000K



Référence	Désignation	Prix public € H.T.	Prix promo € H.T.	CODE EAN
ARI50230	PROJECTEUR ELFI BLC 60 10W/4000K	32,45 €	20,00 €	3 170070 502302

## PROJECTEUR DÉTECTEUR LED 20W - 30W - 50W



Référence	Désignation	Prix public € H.T.	Prix promo € H.T.	CODE EAN
LUM970	PROJECTEUR DÉTECTEUR LED 20W 1800LM 4200K	80,00 €	25,00 €	3 700005 309708
LUM971	PROJECTEUR DÉTECTEUR LED 30W 2700LM 4200K	80,00 €	45,00 €	3 700005 309517



## PROJECTEURS

## PROJECTEUR DÉTECTEUR LED 20W - 30W - 50W



Référence	Désignation	Prix public € H.T.	Prix promo € H.T.	CODE EAN
LUM972	PROJECTEUR DÉTECTEUR LED 50W 4500LM 4200	90,00 €	55,00 €	 3 700005 309722

## PROJECTEUR DTC 102-180 10W BLANC



Référence	Désignation	Prix public € H.T.	Prix promo € H.T.	CODE EAN
THE1020911	PROJECTEUR DTC 102-180 10W BLANC	104,60 €	49,00 €	 4 003468 100431
THE1020913	PROJECTEUR DTC 102-180 20W BLANC	142,20 €	64,00 €	 4 003468 100455
THE1020915	PROJECTEUR DTC 102-180 30W BLANC	186,85 €	85,00 €	 4 003468 100479

## PROJECTEUR LED RGB 20W PADLIGHT



Référence	Désignation	Prix public € H.T.	Prix promo € H.T.	CODE EAN
VELIS744	PROJECTEUR LED RGB 20W PADLIGHT	59,00 €	35,00 €	 8 003910 105119

# PROJECTEURS

## YAKO PERF RGBW 20W NR

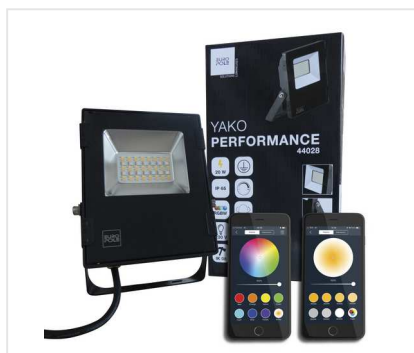

Référence	Désignation	Prix public € H.T.	Prix promo € H.T.	CODE EAN
EUR44028	YAKO PERF RGBW 20W NR	166,40 €	99,00 €	9 0001 00 000628

## PROJECTEURS LED - HAGER



Référence	Désignation	Prix public € H.T.	Prix promo € H.T.	Couleur	CODE EAN
HAGEE636	PROJECTEUR LED 12W BLANC	60,47 €	38,00 €	○	3 250612 256068
HAGEE642	PROJECTEUR LED 12W NOIR DÉTECTEUR	67,00 €	43,00 €	●	3 250612 256105
HAGEE632	PROJECTEUR LED 12W BLANC DÉTECTEUR	67,00 €	43,00 €	○	3 250612 256020
HAGEE637	PROJECTEUR LED 20W BLANC	72,15 €	46,00 €	○	3 250612 256075
HAGEE643	PROJECTEUR LED 20W NOIR DÉTECTEUR	83,75 €	53,00 €	●	3 250612 256112
HAGEE633	PROJECTEUR LED 20W BLANC DÉTECTEUR	83,72 €	53,00 €	○	3 250612 256037
HAGEE638	PROJECTEUR LED 30W BLANC	92,80 €	59,00 €	○	3 250612 256082



## PROJECTEURS

## PROJECTEURS LED - HAGER



Référence	Désignation	Prix public € H.T.	Prix promo € H.T.	Couleur	CODE EAN
HAGEE644	PROJECTEUR LED 30W NOIR DÉTECTEUR	104,35 €	66,00 €	●	3 250612 256129
HAGEE634	PROJECTEUR LED 30W BLANC DÉTECTEUR	104,37 €	66,00 €	○	3 250612 256044

## PROJECTEUR LED SPOT AVEC DÉTECTEUR DE MOUVEMENT



Référence	Désignation	Prix public € H.T.	Prix promo € H.T.	CODE EAN
THE1020981	THELEDA S10 M BLANC	114,85 €	66,00 €	4 003468 100981
THE1020983	THELEDA S20 M BLANC	155,25 €	87,00 €	4 003468 101056



## PROJECTEURS

### PROJECTEUR ZODIAK LED 10W/4000K IP65



Référence	Désignation	Prix public € H.T.	Prix promo € H.T.	CODE EAN
ARI50393	PROJECTEUR ZODIAK LED 10W/4000K IP65	27,80 €	16,00 €	3 170070 503934

### PROJECTEUR LED RECHARGEABLE



Référence	Désignation	Prix public € H.T.	Prix promo € H.T.	CODE EAN
LUM913	PROJECTEUR LED RECHARGEABLE 10W I-PSF10-800	100,00 €	38,00 €	3 700005 309135
LUM897	PROJECTEUR LED RECHARGEABLE 20W	155,00 €	58,00 €	3 700005 308978

### YAH PROJECTEURS SUR PIQUET



Référence	Désignation	Prix public € H.T.	Prix promo € H.T.	CODE EAN
EUR391110	YAH GU10 35W N. MAT 230V	76,75 €	39,00 €	9 000100 000574
EUR390131	YAH LED EVO NO 5W 4000K 38 23	153,60 €	75,00 €	9 100000 000107



## PROJECTEURS

## EMBOU MAT D60MM POUR PROJECTEUR



Référence	Désignation	Prix public € H.T.	Prix promo € H.T.	CODE EAN
EUR3916	EMBOU MAT D60MM POUR PROJECTEUR YAKO	63,90 €	32,00 €	 9 0001 00 000574

## PIQUETS PROJECTEUR



Référence	Désignation	Prix public € H.T.	Prix promo € H.T.	CODE EAN
LUM888	PIQUET PROJECTEUR 10&20W	6,00 €	3,00 €	 3 700005 308886
LUM889	PIQUET PROJECTEUR 30&50W	10,85 €	4,99 €	 3 700005 308893

## PROJECTEUR LED 20000LM



Référence	Désignation	Prix public € H.T.	Prix promo € H.T.	CODE EAN
GEWGWP2174AD	PROJECTEUR LED 20000LM SYMÉTRIQUE S1 VARIABLE DALI SMART PRO 1M 4000K	829,36 €	359,00 €	 8 034035 005565

# EXTÉRIEUR ET JARDIN

## LAMPADAIRE EXTÉRIEUR



Référence	Désignation	Prix public € H.T.	Prix promo € H.T.	CODE EAN
SLV233447	RUSTY SLOT 50 LED	373,30 €	199,00 €	4 024163 157513
SLV231371	ARROCK STONE LED 75 CARRÉ	494,10 €	261,00 €	4 024163 156370

## MINILEAR

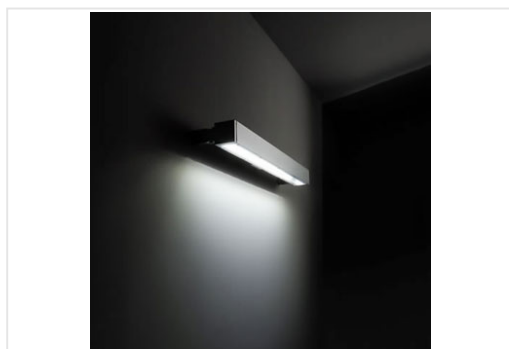

Référence	Désignation	Prix public € H.T.	Prix promo € H.T.	CODE EAN
TRFSIM-S5498W19	MINILEAR	848,82 €	409,00 €	8 033357 614202

## MINISKILL

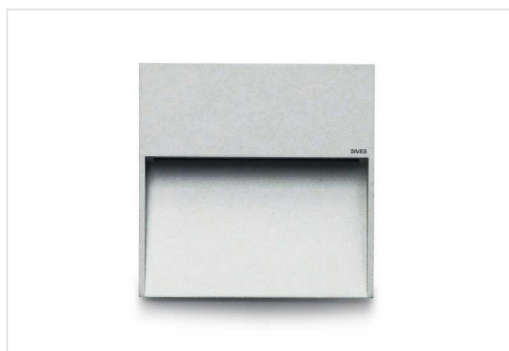

Référence	Désignation	Prix public € H.T.	Prix promo € H.T.	CODE EAN
TRFSIM-S6250W14	MINISKILL 105X105	242,14 €	117,00 €	8 033357 714292
TRFSIM-S6260W14	MINISKILL 200X200	434,76 €	210,00 €	8 033357 654703

## EXTÉRIEUR ET JARDIN

## APPLIQUE ET PLAFONNIER EXTÉRIEUR TERANG



Référence	Désignation	Prix public € H.T.	Prix promo € H.T.	Couleur	CODE EAN
SLV229924	TERANG LED GRIS 11W	76,75 €	34,00 €	●	4 0241 63 140546
SLV229925	TERANG LED ANTHRACITE 11W	76,75 €	34,00 €	●	4 0241 63 140560
SLV229927	TERANG LED FONTE ROUILLÉE 11W	76,75 €	34,00 €	●	4 0241 63 150675

## APPLIQUE MURALE À LED



Référence	Désignation	Prix public € H.T.	Prix promo € H.T.	CODE EAN
SMA10.048.23	APPLIQUE MODERNE EN ALU ET LED	110,97 €	43,00 €	8 711 387 168307
SMA10.048.24	APPLIQUE MODERNE EN ALU ET LED	103,72 €	43,00 €	8 711 387 168307

## EXTÉRIEUR ET JARDIN

### APPLIQUE MURALE À LED INTÉGRÉ AVEC CAPTEUR JOUR / NUIT



Référence	Désignation	Prix public € H.T.	Prix promo € H.T.	CODE EAN
SMA10.045.31	LUMINAIRE D'ENTRÉE AVEC NUMÉRO	65,66 €	24,00 €	8 711 387 169052

### APPLIQUE MURALE AVEC SOCLE

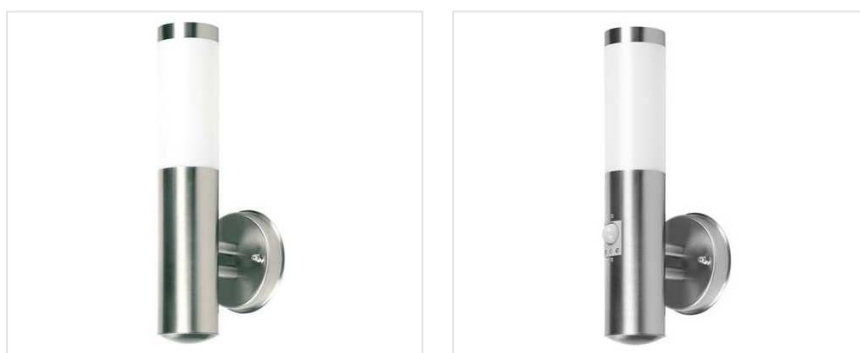

Référence	Désignation	Prix public € H.T.	Prix promo € H.T.	CODE EAN
SMA10.042.72	APPLIQUE - RX1010-38R RANEX	37,77 €	14,00 €	8 711 387 012525
SMA10.042.73	APPLIQUE AVEC DÉTECTEUR DE MOU	62,70 €	24,00 €	8 711 387 052613

### APPLIQUE MURALE BASTIA



Référence	Désignation	Prix public € H.T.	Prix promo € H.T.	CODE EAN
SMA10.011.55	APPLIQUE BASTIA CARRÉ	36,16 €	15,00 €	8 711 387 096495
SMA10.011.57	APPLIQUE BASTIA OVAL	37,19 €	15,00 €	8 711 387 096518

## EXTÉRIEUR ET JARDIN

## APPLIQUE MURALE BASTIA



**DESTOCKAGE**

Référence	Désignation	Prix public € H.T.	Prix promo € H.T.	CODE EAN
SMA10.011.58	DOUBLE APPLIQUE BASTIA OVAL	60,94 €	25,00 €	8 711 387 096525

## APPLIQUE MURALE BASTIA



Référence	Désignation	Prix public € H.T.	Prix promo € H.T.	CODE EAN
SMA10.010.53	APPLIQUE BASTIA	29,10 €	11,00 €	8 711 387 095146

## APPLIQUE MURALE D'EXTÉRIEUR



Référence	Désignation	Prix public € H.T.	Prix promo € H.T.	CODE EAN
SMA10.042.69	APPLIQUE	21,01 €	9,00 €	8 711 387 048777

## EXTÉRIEUR ET JARDIN

### APPLIQUE MURALE D'EXTÉRIEUR AVEC DÉTECTEUR



Référence	Désignation	Prix public € H.T.	Prix promo € H.T.	CODE EAN
SMA10.020.73	APPLIQUE EXTÉRIEURE AVEC DÉTECTEUR	103,36 €	37,00 €	8 711 387 100529

### APPLIQUE MURALE D'EXTÉRIEUR EN MÉTAL



Référence	Désignation	Prix public € H.T.	Prix promo € H.T.	CODE EAN
SMA10.048.06	APPLIQUE D'EXTÉRIEUR EN MÉTAL	37,15 €	14,00 €	8 711 387 170119

### APPLIQUE MURALE D'EXTÉRIEUR HAUT/BAS GRISE



Référence	Désignation	Prix public € H.T.	Prix promo € H.T.	CODE EAN
SMA10.027.31	APPLIQUE HAUT/BAS GRISE	75,65 €	28,00 €	8 711 387 081491



## EXTÉRIEUR ET JARDIN

## APPLIQUE MURALE D'EXTÉRIEUR MODERNE



Référence	Désignation	Prix public € H.T.	Prix promo € H.T.	CODE EAN
SMA10.042.28	APPLIQUE CARRÉ LED INTÉGRÉES	135,24 €	51,00 €	8 711 387 082696

## APPLIQUE MURALE D'EXTÉRIEUR RONDE



Référence	Désignation	Prix public € H.T.	Prix promo € H.T.	CODE EAN
SMA5000.450	APPLIQUE BURGOS NOIR	37,73 €	14,00 €	8 711 387 096358

## APPLIQUE MURALE EXTÉRIEURE EN MÉTAL



Référence	Désignation	Prix public € H.T.	Prix promo € H.T.	CODE EAN
SMA10.048.08	APPLIQUE D'EXTÉRIEUR EN MÉTAL	50,58 €	18,00 €	8 711 387 170393



# EXTÉRIEUR ET JARDIN

## MERIDIAN BOX E27



Référence	Désignation	Prix public € H.T.	Prix promo € H.T.	Couleur	CODE EAN
SLV230045	MERIDIAN BOX ANTHRACITE E27	109,70 €	50,00 €	●	4 0241 63 12389 1
SLV230044	MERIDIAN BOX GRIS ARGENT E27	109,70 €	59,00 €	●	4 0241 63 12388 4
SLV230655	MERIDIAN BOX 2 ANTHRACITE	126,15 €	64,00 €	●	4 0241 63 15612 7
SLV230657	MERIDIAN BOX 2 FONTE ROUILLÉE	126,15 €	64,00 €	●	4 0241 63 15613 4

## APPLIQUE MURALE GLASGOW



Référence	Désignation	Prix public € H.T.	Prix promo € H.T.	CODE EAN
SMA10.010.67	APPLIQUE GLASGOW	86,71 €	34,00 €	8 711 387 09530 6

## EXTÉRIEUR ET JARDIN

## APPLIQUE MURALE HAUT ET BAS



Référence	Désignation	Prix public € H.T.	Prix promo € H.T.	CODE EAN
SMA10.048.27	APPLIQUE MODERNE EN ALU ET LED	103,72 €	40,00 €	8 711 387 168376

## APPLIQUE MURALE LED LORNA AVEC/SANS DÉTECTEUR



Référence	Désignation	Prix public € H.T.	Prix promo € H.T.	CODE EAN
SMA5000.488	APPLIQUE LED LORNA	60,79 €	29,00 €	8 711 387 096747
SMA10.068.51	APPLIQUE LED LORNA AVEC DÉTECTEUR	88,02 €	33,00 €	8 711 387 096723

## APPLIQUE MURALE ORIENTABLE AVEC DÉTECTEUR



Référence	Désignation	Prix public € H.T.	Prix promo € H.T.	CODE EAN
SMA10.048.05	APPLIQUE SPOT ORIENTABLE D'EXTÉRIEUR	62,18 €	24,00 €	8 711 387 170041

## EXTÉRIEUR ET JARDIN

### APPLIQUE MURALE RÉTRO EN ALU



Référence	Désignation	Prix public € H.T.	Prix promo € H.T.	CODE EAN
SMA10.048.25	APPLIQUE RÉTRO EN ALU	63,76 €	21,00 €	8 711 387 168444

### ÉCLAIRAGE D'EXTÉRIEUR À LED



Référence	Désignation	Prix public € H.T.	Prix promo € H.T.	CODE EAN
SMA10.042.25	APPLIQUE EXTÉRIEURE LED DE 10W	46,30 €	17,00 €	8 711 387 082627

### LAMPE À POSER D'EXTÉRIEUR ADEGAN MANILA



Référence	Désignation	Prix public € H.T.	Prix promo € H.T.	CODE EAN
SLV231385	ADEGAN MANILA TL ANTHRACITE	439,20 €	197,00 €	4 0241 63 140232

## EXTÉRIEUR ET JARDIN

## LAMPADAIRE EXTÉRIEUR ADEGAN MANILA



Référence	Désignation	Prix public € H.T.	Prix promo € H.T.	CODE EAN
SLV231395	ADEGAN MANILA SL ANTHRACITE	439,20 €	234,00 €	 4 0241 63 140225

## LAMPADAIRE EXTÉRIEUR BOOKAT



Référence	Désignation	Prix public € H.T.	Prix promo € H.T.	CODE EAN
SLV231855	BOOKAT ANTHRACITE	494,10 €	250,00 €	 4 0241 63 157841

## LAMPADAIRE EXTÉRIEUR SLOTS 65



Référence	Désignation	Prix public € H.T.	Prix promo € H.T.	Couleur	CODE EAN
SLV231457	SLOTS 65 FONTE ROUILLÉE	252,55 €	122,00 €		 4 0241 63 150842

## EXTÉRIEUR ET JARDIN

## KIT DE 3 SPOTS LED ENCASTRABLE



Référence	Désignation	Prix public € H.T.	Prix promo € H.T.	CODE EAN
SMA5000.158	KIT DE 3 SPOTS LED ENCASTRABLE	145,23 €	52,00 €	8 711 387 052644

## PLAFONNIER/APPLIQUE D'EXTÉRIEUR DUBLIN



Référence	Désignation	Prix public € H.T.	Prix promo € H.T.	CODE EAN
SMA10.010.36	PLAFONNIER/APPLIQUE DUBLIN	61,56 €	24,00 €	8 711 387 094958

## LAMPE DE JARDIN LED



Référence	Désignation	Prix public € H.T.	Prix promo € H.T.	CODE EAN
SMA10.042.29	LAMPE DE JARDIN LED	138,13 €	49,00 €	8 711 387 082764



## EXTÉRIEUR ET JARDIN

## POTEAUX DE JARDIN EXTÉRIEUR

**DESTOCKAGE**

Référence	Désignation	Prix public € H.T.	Prix promo € H.T.	CODE EAN
SMA10.042.74	BALISE DE JARDIN	36,09 €	13,00 €	8 711 387 048845
SMA10.042.75	BALISE DE JARDIN AVEC DÉTECTEUR	60,83 €	28,00 €	8 711 387 052590
SMA10.042.70	BORNE DE JARDIN	64,20 €	23,00 €	8 711 387 052743

## POTELET DE JARDIN LED INTÉGRÉ



Référence	Désignation	Prix public € H.T.	Prix promo € H.T.	CODE EAN
SMA10.024.46	POTELET DE JARDIN LEDS INTÉGRÉS	163,42 €	58,00 €	8 711 387 083518

## BORNE LUNA 250 410MM BLC/OPALE





Référence	Désignation	Prix public € H.T.	Prix promo € H.T.	CODE EAN
ARI1717	BORNE LUNA 250 410MM BLC/OPALE	45,70 €	28,00 €	3 170070 017172



## LES ENCASTRÉS DÉCO

## COLERETTE ALU CARRÉ FINITION ALU



Référence	Désignation	Prix public € H.T.	Prix promo € H.T.	CODE EAN
EUR26201	COLERETTE ALU CARRÉ FINITION ALU	22,95 €	13,00 €	 9 0001 00 000574
EUR26202	COLLERETTE GU10 + GU5,3 2PTS ALU	51,10 €	27,00 €	 9 100000 000107

## COLLERETTES BE BEST 1/4 TOUR ORIENTABLE



Référence	Désignation	Prix public € H.T.	Prix promo € H.T.	Couleur	CODE EAN
EUR2413	COLLERETTE GU10 ALU ORI	13,60 €	7,00 €	●	 9 100000 000107
EUR2414	COLLERETTE GU10 BLANC ORI	13,60 €	8,00 €	○	 9 0001 00 000567
EUR2415	COLLERETTE GU10 NOIR ORI	13,60 €	7,00 €	●	 9 100000 000107
EUR2534	COLLERETTE GU5,3 BLANC ORI	11,90 €	6,00 €	○	 9 0001 00 000567
EUR256524	COLERETTE IP65 BEBEST BLANC ORI	36,10 €	16,00 €	○	 9 0001 00 000574



## LES ENCASTRÉS DÉCO

### COLLERETTE ÉVASÉE DÉCO ROND BLANC



Référence	Désignation	Prix public € H.T.	Prix promo € H.T.	CODE EAN
EUR26810	COLLERETTE ÉVASÉE DÉCO ROND BLANC	26,75 €	11,00 €	9 000100 000574

### LED SPOT À ENCASTRER



Référence	Désignation	Prix public € H.T.	Prix promo € H.T.	CODE EAN
GEL93066766	SPOTLIGHT 6W 840K 550LM	16,50 €	9,90 €	1 006489 457457
GEL93066767	SPOTLIGHT 6W 865K 550LM	16,50 €	9,90 €	1 006489 457457
GEL93100534	SPOTLIGHT CARRE 6W 865K 550LM	18,00 €	9,90 €	9 000100 000611

### COLLERETTE ET MODULE LED CX 220-240V 8W FIXE



Référence	Désignation	Prix public € H.T.	Prix promo € H.T.	CODE EAN
AURENBZE8W	COLLERETTE BLANCHE POUR E8	6,15 €	3,00 €	5 055155 401733

## LES ENCASTRÉS DÉCO

COLLERETTE ET MODULE LED CX 220-240V 8W FIXE





Référence	Désignation	Prix public € H.T.	Prix promo € H.T.	CODE EAN
AURENDE8CX	MODULE LED CX 220-240V 8W FIXE	53,45 €	23,40 €	 5 0561 02 0084 18

## LES ENCASTRÉS DE SOL

### ENCASTRÉ DE SOL ROND INOX BOUNTY



Référence	Désignation	Prix public € H.T.	Prix promo € H.T.	CODE EAN
EUR5003	ENCASTRÉ DE SOL ROND INOX 316L	76,75 €	45,00 €	 9 0001 00 000574
EUR5004	ENCASTRÉ DEE SOL BOUNTY2 CARRÉ GU5,3/GU10 IP65	76,75 €	45,00 €	 9 0001 00 000628

### ENCASTRÉ DE SOL EXTÉRIEUR DASAR



Référence	Désignation	Prix public € H.T.	Prix promo € H.T.	CODE EAN
SLV229270	DASAR HIT-T 70W ROND	505,10 €	289,00 €	 4 0241 63 096652



# SUSPENSIONS, LAMPADAIRES ET LAMPES À POSER

## ABAT-JOUR FENDA 15CM



Référence	Désignation	Prix public € H.T.	Prix promo € H.T.	Couleur	CODE EAN
SLV156141	FENDA ABAT-JOUR 15CM BLANC	43,80 €	29,00 €	●	4 0241 63 168380
SLV156143	FENDA ABAT-JOUR 15CM BEIGE	43,80 €	29,00 €	●	4 0241 63 168397
SLV156146	FENDA ABAT-JOUR 15CM BORDEAUX	54,80 €	31,00 €	●	4 0241 63 168427
SLV156147	FENDA ABAT-JOUR 15CM BLEU	54,80 €	29,00 €	●	4 0241 63 168434
SLV156152	FENDA ABAT-JOUR 15CM NOIR/CUIVRE	54,80 €	36,00 €	●	4 0241 63 171878

## ABAT-JOUR FENDA 30 CM et 45 CM



Référence	Désignation	Prix public € H.T.	Prix promo € H.T.	Couleur	CODE EAN
SLV155582	FENDA ABAT-JOUR 30 CM BLANC	54,80 €	31,00 €	●	4 0241 63 152129
SLV155583	FENDA ABAT-JOUR 30 CM BEIGE	54,80 €	31,00 €	●	4 0241 63 152136
SLV155584	FENDA ABAT-JOUR 30 CM JAUNE	60,30 €	31,00 €	●	4 0241 63 152143
SLV155586	FENDA ABAT-JOUR 30 CM BORDEAUX	60,30 €	31,00 €	●	4 0241 63 152167
SLV155592	FENDA ABAT-JOUR 30 CM NOIR/CUIVRE	65,75 €	41,00 €	●	4 0241 63 167741
SLV156113	FENDA ABAT-JOUR 45CM BEIGE	87,75 €	46,00 €	●	4 0241 63 168274
SLV156116	FENDA ABAT-JOUR 45CM BORDEAUX	93,20 €	47,00 €	●	4 0241 63 168304
SLV156119	FENDA ABAT-JOUR 45CM ROSE	93,20 €	47,00 €	●	4 0241 63 168328



## SUSPENSIONS, LAMPADAIRES ET LAMPES À POSER

ABAT-JOUR FENDA 30 CM et 45 CM



Référence	Désignation	Prix public € H.T.	Prix promo € H.T.	Couleur	CODE EAN
SLV156122	FENDA ABAT-JOUR 45CM NOIR/CUIVRE	98,70 €	47,00 €	●	4 0241 63 168359

SUSPENSION SOPRANA CONE PD-2



Référence	Désignation	Prix public € H.T.	Prix promo € H.T.	CODE EAN
SLV155770	SOPRANA CONE PD-2 DIFF TISSU	175,55 €	82,00 €	4 0241 63 137867

PIED DE LAMPE DE BUREAU FENDA



Référence	Désignation	Prix public € H.T.	Prix promo € H.T.	Couleur	CODE EAN
SLV155780	FENDA PIED DE LAMPE NOIR	87,75 €	47,00 €	●	4 0241 63 167710

## SUSPENSIONS, LAMPADAIRES ET LAMPES À POSER

### PIED DE LAMPE FENDA MÉTAL BROSSÉ



**DESTOCKAGE**

Référence	Désignation	Prix public € H.T.	Prix promo € H.T.	Couleur	CODE EAN
SLV155785	FENDA PIED DE LAMPE METAL BROSSÉ	98,70 €	47,00 €	●	4 0241 63 167697

### PIED DE LAMPADAIRE FENDA



**DESTOCKAGE**

Référence	Désignation	Prix public € H.T.	Prix promo € H.T.	Couleur	CODE EAN
SLV155790	FENDA LAMPADAIRE NOIR	142,65 €	72,00 €	●	4 0241 63 167703

### LAMPE DE BUREAU SOPRANA OVAL



**DESTOCKAGE**

Référence	Désignation	Prix public € H.T.	Prix promo € H.T.	CODE EAN
SLV155841	SOPRANA OVAL TL-1 DIFF BLANC	186,55 €	93,00 €	4 0241 63 143714

## SUSPENSIONS, LAMPADAIRES ET LAMPES À POSER

## SUSPENSION TRIADEM



Référence	Désignation	Prix public € H.T.	Prix promo € H.T.	CODE EAN
SLV155871	TRIADEM SUSPENSION CHROME/BLANC	521,55 €	234,00 €	4 024163 147934

## SUSPENSION FORCHINI M PD-1



Référence	Désignation	Prix public € H.T.	Prix promo € H.T.	CODE EAN
SLV155930	FORCHINI M PD-1 50CM NOIR/OR	384,30 €	208,00 €	4 024163 136976

## LAMPADAIRE TENORA FL-1 DIFFUSEUR



Référence	Désignation	Prix public € H.T.	Prix promo € H.T.	Couleur	CODE EAN
SLV156030	TENORA FL-1 CHROME DIFFUSEUR NOIR	549,00 €	295,00 €	●	4 024163 148160
SLV156031	TENORA FL-1 CHROME DIFFUSEUR BLANC	549,00 €	295,00 €	○	4 024163 148177



# SUSPENSIONS, LAMPADAIRES ET LAMPES À POSER

## SUSPENSION I-RING BLANC



Référence	Désignation	Prix public € H.T.	Prix promo € H.T.	CODE EAN
SLV156301	I-RING BLANC 15 7W 3000K	384,30 €	172,00 €	4 0241 63 157803

## SUSPENSION LED PANEL ROND



Référence	Désignation	Prix public € H.T.	Prix promo € H.T.	CODE EAN
SLV1001348	LED PANEL ROND GRIS ARGENTÉ 4000K	356,85 €	214,00 €	4 0241 63 196475
SLV158634	LED PANEL ROND GRIS ARG 4000K	356,85 €	199,00 €	4 0241 63 148894

## DECANTER BLANC GESSO 320 3000



Référence	Désignation	Prix public € H.T.	Prix promo € H.T.	CODE EAN
TAR1T4082	DECANTER BLANC GESSO 320 3000	738,40 €	479,96 €	8 007753 426653

## SUSPENSIONS, LAMPADAIRES ET LAMPES À POSER

## PANTHEON LED SUSPENSION 400MM 10W



Référence	Désignation	Prix public € H.T.	Prix promo € H.T.	CODE EAN
TAR1T4055	PANTHEON LED SUSPENSION 400MM 10W	350,25 €	227,66 €	8 007753 428305

## PIED DE LAMPE FENDA CHROMÉ 40W



**DESTOCKAGE**

Référence	Désignation	Prix public € H.T.	Prix promo € H.T.	CODE EAN
SLV155542	FENDA PIED DE LAMPE CHROME 40W	98,70 €	47,00 €	4 024163 152006

## PLAFONNIER ET SUSPENSION FENDA PATERE



**DESTOCKAGE**

Référence	Désignation	Prix public € H.T.	Prix promo € H.T.	CODE EAN
SLV155551	FENDA PATERE BLANCHE	49,30 €	28,00 €	4 024163 166461
SLV155561	FENDA SUSPENSION RIGIDE PATERE BLANC	60,30 €	32,00 €	4 024163 166485

# SUSPENSIONS, LAMPADAIRES ET LAMPES À POSER

## SUSPENSION BISHADE PD-1 3X E27



Référence	Désignation	Prix public € H.T.	Prix promo € H.T.	CODE EAN
SLV155650	BISHADE PD-1 3X E27	384,30 €	185,00 €	 4 0241 63 132879

## LAMPE DE BUREAU BISHADE TL-1



Référence	Désignation	Prix public € H.T.	Prix promo € H.T.	CODE EAN
SLV155651	BISHADE TL-1 E27 MAX. 40W	208,50 €	103,00 €	 4 0241 63 132879

## LAMPADAIRE BISHADE SL-1



Référence	Désignation	Prix public € H.T.	Prix promo € H.T.	CODE EAN
SLV155652	BISHADE SL-1 LAMPADAIRE E27	384,30 €	197,00 €	 4 0241 63 132862



## SUSPENSIONS, LAMPADAIRES ET LAMPES À POSER

## PIED DE LAMPE FENDA BETON



Référence	Désignation	Prix public € H.T.	Prix promo € H.T.	Couleur	CODE EAN
SLV155690	FENDA PIED DE LAMPE BETON GRIS	109,70 €	52,00 €	●	4 0241 63 167673

## SUSPENSION SOPRANA SOLID



Référence	Désignation	Prix public € H.T.	Prix promo € H.T.	CODE EAN
SLV155710	SOPRANA SOLID PD-1 GRIS	175,55 €	82,00 €	4 0241 63 131513
SLV155712	SOPRANA SOLID PD-1 GRIS	219,50 €	103,00 €	4 0241 63 148375
SLV155713	SOPRANA SOLID PD-4 SUSPENSION	219,50 €	103,00 €	4 0241 63 148382

## LAMPADAIRE SOPRANA BOW SL-1 E27



Référence	Désignation	Prix public € H.T.	Prix promo € H.T.	Couleur	CODE EAN
SLV155723	SOPRANA BOW SL-1 BLANC E27	466,65 €	209,00 €	○	4 0241 63 137812

# SUSPENSIONS, LAMPADAIRES ET LAMPES À POSER

## LAMPADAIRE SOPRANA BOW SL-1 E27



Référence	Désignation	Prix public € H.T.	Prix promo € H.T.	Couleur	CODE EAN
SLV155720	SOPRANA BOW SL-1 NOIR E27	466,65 €	209,00 €	●	4 0241 63 137805

## SUSPENSION MEDO LED ALU



Référence	Désignation	Prix public € H.T.	Prix promo € H.T.	CODE EAN
SLV149286	MEDO LED SUSPENSION ALU 18W 3000K	318,40 €	157,00 €	4 0241 63 156356

## SUSPENSION MALANG LED



**COULEURS VARIABLES RGB**

Référence	Désignation	Prix public € H.T.	Prix promo € H.T.	CODE EAN
SLV147213	MALANG LED VERSION ESCLAVE	768,60 €	368,00 €	4 0241 63 091695
SLV147203	MALANG LED VERSION MAITRE	823,50 €	395,00 €	4 0241 63 091466

## SUSPENSIONS, LAMPADAIRES ET LAMPES À POSER

## SUSPENSION MEDO 90 RING



Référence	Désignation	Prix public € H.T.	Prix promo € H.T.	CODE EAN
SLV133851	MEDO 90 RING SUSPENSION BLANCHE	1262,70 €	585,00 €	4 0241 63 148405

## SLIM WALL LED WALL U/D LED 24W



Référence	Désignation	Prix public € H.T.	Prix promo € H.T.	CODE EAN
TAR1T4193	SLIM WALL LED WALL U/D LED 24W	465,80 €	302,77 €	8 007753 429753

## SUSPENSION FITU E27 RONDE ALU



Référence	Désignation	Prix public € H.T.	Prix promo € H.T.	CODE EAN
SLV132656	FITU E27 SUSPENSION RONDE ALU	49,30 €	29,00 €	4 0241 63 157148

# SUSPENSIONS, LAMPADAIRES ET LAMPES À POSER

## SUSPENSION PHELIA RONDE



Référence	Désignation	Prix public € H.T.	Prix promo € H.T.	CODE EAN
SLV133300	PHELIA S SUSPENSION RONDE NOIRE	153,60 €	73,00 €	 4 0241 63 157902

## ENOLA\_B PD-1 GRIS ARGENT/NOIR



Référence	Désignation	Prix public € H.T.	Prix promo € H.T.	CODE EAN
SLV151854	ENOLA_B PD-1 GRIS ARGENT/NOIR	120,65 €	58,00 €	 4 0241 63 141604

## SUSPENSION ORION E14



Référence	Désignation	Prix public € H.T.	Prix promo € H.T.	CODE EAN
SLV133660	ORION S BEIGE E14	109,70 €	54,00 €	 4 0241 63 143431



## SUSPENSIONS, LAMPADAIRES ET LAMPES À POSER

## SUSPENSION LED E27



**DESTOCKAGE**

Référence	Désignation	Prix public € H.T.	Prix promo € H.T.	CODE EAN
ARI4175	SUSPENSION DIANA 140 E27 S/LPE	104,75 €	55,00 €	 3 170070 041757
ARI50448	SUSPENSION JULIA LED 4 8W/3000K	139,10 €	79,00 €	 3 170070 504481

## SUSPENSION RONDE CUIVRE/NOIR



Référence	Désignation	Prix public € H.T.	Prix promo € H.T.	CODE EAN
SMA10.044.41	SUSPENSION RONDE CUIVRE/NOIR	29,99 €	19,00 €	 8 711387 166969

## SUSPENSION PLATE CUIVRE/NOIR



**DESTOCKAGE**

Référence	Désignation	Prix public € H.T.	Prix promo € H.T.	CODE EAN
SMA10.044.43	SUSPENSION PLATE CUIVRE/NOIR	19,99 €	12,00 €	 8 711387 167522



# SUSPENSIONS, LAMPADAIRES ET LAMPES À POSER

## SUSPENSION LIÈGE



Référence	Désignation	Prix public € H.T.	Prix promo € H.T.	CODE EAN
SMAIDE-60016	SUSPENSION LIÈGE	16,99 €	7,00 €	8 711 387 158612

## SUSPENSION MÉTAL



Référence	Désignation	Prix public € H.T.	Prix promo € H.T.	Couleur	CODE EAN
SMAIDE-60013	SUSPENSION MÉTAL ARGENT	14,99 €	7,00 €	●	8 711 387 172007
SMAIDE-60014	SUSPENSION MÉTAL OR ROSE	14,99 €	7,00 €	●	8 711 387 172144
SMAIDE-60015	SUSPENSION MÉTAL OR	14,99 €	7,00 €	●	8 711 387 172359

## SUSPENSION CIMENT BRUT



Référence	Désignation	Prix public € H.T.	Prix promo € H.T.	CODE EAN
SMAIDE-60010	SUSPENSION CIMENT BRUT	16,99 €	9,00 €	8 711 387 158551
SMAIDE-60011	SUSPENSION CIMENT BRUT	16,99 €	9,00 €	8 711 387 158575

## SUSPENSIONS, LAMPADAIRES ET LAMPES À POSER

## SUSPENSION CIMENT BRUT



Référence	Désignation	Prix public € H.T.	Prix promo € H.T.	CODE EAN
SMAIDE-60012	SUSPENSION CIMENT BRUT	16,99 €	9,00 €	8 711387 158599

## LUMINAIRE SUSPENDU À RÉFLECTEUR PC PRISMATIQUE



Référence	Désignation	Prix public € H.T.	Prix promo € H.T.	CODE EAN
TRI5996510	EGO II E27	98,60 €	65,00 €	9 000005 000006

## SUSPENSION ELGA IP20



Référence	Désignation	Prix public € H.T.	Prix promo € H.T.	CODE EAN
NOV684A-G05X1A-02	SUSPENSION ELGA IP20 E27 60W	69,00 €	39,00 €	8 435256 542165

# SUSPENSIONS, LAMPADAIRES ET LAMPES À POSER

## SUSPENSION BAGUET IP20

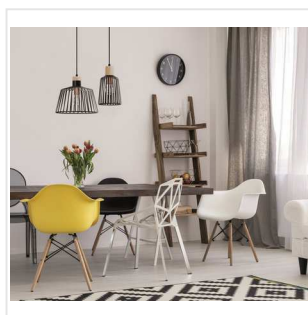

Référence	Désignation	Prix public € H.T.	Prix promo € H.T.	CODE EAN
NOV685A-G05X1A-02	SUSPENSION BAGUET IP20 E27 60	103,50 €	65,00 €	8 435256 542172
NOV685B-G05X1A-02	SUSPENSION BAGUET IP20 E27 60	120,06 €	75,00 €	8 435256 542325

## SUSPENSION CUSKA IP20



Référence	Désignation	Prix public € H.T.	Prix promo € H.T.	CODE EAN
NOV720B-G05X1A-50	SUSPENSION CUSKA IP20 E27 60	129,72 €	80,00 €	8 435258 618097

## SUSPENSION NAE LED 21W 1700LM



Référence	Désignation	Prix public € H.T.	Prix promo € H.T.	CODE EAN
NOV797A-L0121B-92	SUSPENSION NAE LED 21W 1700LM	342,24 €	199,00 €	8 433264 071349

## SUSPENSIONS, LAMPADAIRES ET LAMPES À POSER

SUSPENSION GHO LED 60W 3187LM



Référence	Désignation	Prix public € H.T.	Prix promo € H.T.	CODE EAN
NOV802B-L3360B-01	SUSPENSION GHO LED 60W 3187LM	841,80 €	420,00 €	 8 433264 071509



## APPLIQUES ET PLAFONNIERS

THREESIXTY 23W 384 U/D OPAL 3



Référence	Désignation	Prix public € H.T.	Prix promo € H.T.	CODE EAN
TAR1T6090EL	THREESIXTY 23W 384 U/D OPAL 3	875,50 €	569,08 €	8 007753 704966

DIO FLEX PLUG CHROME/BLANC



Référence	Désignation	Prix public € H.T.	Prix promo € H.T.	CODE EAN
SLV146632	DIO FLEX PLUG CHROME/BLANC	49,30 €	30,00 €	4 024163 111522

ORDI ANTHRACITE



Référence	Désignation	Prix public € H.T.	Prix promo € H.T.	CODE EAN
SLV232905	ORDI ANTHRACITE	175,55 €	87,00 €	4 024163 151337

## APPLIQUES ET PLAFONNIERS

### MYRA WALL



Référence	Désignation	Prix public € H.T.	Prix promo € H.T.	Couleur	CODE EAN
SLV233105	MYRA WALL ANTHRACITE	109,70 €	53,00 €	●	4 0241 63 140300
SLV233104	MYRA WALL GRIS ARGENT	109,70 €	53,00 €	●	4 0241 63 140294

### MYRA UP/DOWN ANTHRACITE



Référence	Désignation	Prix public € H.T.	Prix promo € H.T.	CODE EAN
SLV233115	MYRA UP/DOWN ANTHRACITE GU10	148,10 €	70,00 €	4 0241 63 140324

### BULAN BLANCHE E14



Référence	Désignation	Prix public € H.T.	Prix promo € H.T.	CODE EAN
SLV229071	BULAN BLANCHE E14	65,75 €	37,00 €	4 0241 63 102490

## APPLIQUES ET PLAFONNIERS

## SOPRANA SOLID WL-1 E14



**DESTOCKAGE**

Référence	Désignation	Prix public € H.T.	Prix promo € H.T.	CODE EAN
SLV155750	SOPRANA SOLID WL-1 E14	153,60 €	78,00 €	4 0241 63 1425 19
SLV155751	SOPRANA SOLID WL-2 E14 60W	153,60 €	78,00 €	4 0241 63 1573 91

## ENOLA\_B UP/DOWN BLANCHE



**DESTOCKAGE**

Référence	Désignation	Prix public € H.T.	Prix promo € H.T.	CODE EAN
SLV151801	ENOLA_B UP/DOWN BLANCHE	126,15 €	64,00 €	4 0241 63 1258 64

## ZENIT 30 GRIS SMD LED 6W



**DESTOCKAGE**

Référence	Désignation	Prix public € H.T.	Prix promo € H.T.	CODE EAN
SLV151884	ZENIT 30 GRIS SMD LED 6W	219,50 €	111,00 €	4 0241 63 1584 42



## APPLIQUES ET PLAFONNIERS

### BARRO 1 ET 2 ROND



Référence	Désignation	Prix public € H.T.	Prix promo € H.T.	CODE EAN
SLV151912	BARRO 1 ROND GRIS ARGENT	109,70 €	56,00 €	 4 0241 63 073790
SLV151922	BARRO 2 GRIS ARGENT 2X GU10	175,55 €	105,00 €	 4 0241 63 073806

### ASTO 1 ALU BROSSE GU10 SPOT



Référence	Désignation	Prix public € H.T.	Prix promo € H.T.	CODE EAN
SLV147441	ASTO 1 ALU BROSSE GU10 SPOT	43,80 €	24,00 €	 4 0241 63 104425
SLV147442	ASTO 2 ALU BROSSE 2X GU10	84,45 €	42,00 €	 4 0241 63 104432
SLV147443	ASTO 3 ALU BROSSE 3X GU10	109,70 €	57,00 €	 4 0241 63 104449
SLV147444	ASTO 4 ALU BROSSE 4X GU10	153,60 €	83,00 €	 4 0241 63 104456

## APPLIQUES ET PLAFONNIERS

## PLASTRA 105 E27 PLATRE BLANC

**DESTOCKAGE**

 PEUT ÊTRE PEINT
 

Référence	Désignation	Prix public € H.T.	Prix promo € H.T.	CODE EAN
SLV148001	PLASTRA 105 E27 PLATRE BLANC	109,70 €	62,00 €	4 0241 63 093354

## PLASTRA CL-1 CARRÉ PLATRE

**DESTOCKAGE**

 PEUT ÊTRE PEINT
 

Référence	Désignation	Prix public € H.T.	Prix promo € H.T.	CODE EAN
SLV148004	PLASTRA CL-1 CARRE PLATRE	76,75 €	45,00 €	4 0241 63 137249

## PLASTRA 100 SLOT PLATRE BLANC

 PEUT ÊTRE PEINT
 

Référence	Désignation	Prix public € H.T.	Prix promo € H.T.	CODE EAN
SLV148010	PLASTRA 100 SLOT PLATRE BLANC	82,25 €	42,00 €	4 0241 63 093415

## APPLIQUES ET PLAFONNIERS

### PLASTRA 103 T5 PLATRE BLANC



**DESTOCKAGE**

PEUT ÊTRE PEINT



Référence  
SLV148011

Désignation  
PLASTRA 103 T5 PLATRE BLANC

Prix public € H.T.  
131,65 €

Prix promo € H.T.  
70,00 €

CODE EAN



### PLASTRA CUBE PLATRE BLANC G9

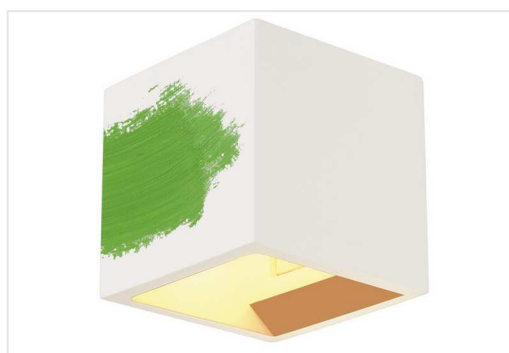

**DESTOCKAGE**

PEUT ÊTRE PEINT



Référence  
SLV148018

Désignation  
PLASTRA CUBE PLATRE BLANC G9

Prix public € H.T.  
71,25 €

Prix promo € H.T.  
36,00 €

CODE EAN



### PLASTRA SQUARE PLATRE BLANC



**DESTOCKAGE**

PEUT ÊTRE PEINT



Référence  
SLV148019

Désignation  
PLASTRA SQUARE PLATRE BLANC

Prix public € H.T.  
252,55 €

Prix promo € H.T.  
123,00 €

CODE EAN



**SOGUADIME**  
LE MATÉRIEL ÉLECTRIQUE

## APPLIQUES ET PLAFONNIERS

## AIR INDI 22 ROND BLANC



Référence	Désignation	Prix public € H.T.	Prix promo € H.T.	CODE EAN
SLV133921	AIR INDI 22 ROND BLANC	219,50 €	128,00 €	4 0241 63 13647 1
SLV133931	AIR INDI 33 ROND BLANC	329,40 €	208,00 €	4 0241 63 13648 8

## PIPOFLEX



Référence	Désignation	Prix public € H.T.	Prix promo € H.T.	Couleur	CODE EAN
SLV146701	PIPOFLEX BLANC MAT	109,70 €	53,00 €	○	4 0241 63 14413 1
SLV146704	PIPOFLEX GRIS ARGENT	109,70 €	56,00 €	●	4 0241 63 14415 5

## LIPSY 50 M COLOR CONTROL



Référence	Désignation	Prix public € H.T.	Prix promo € H.T.	CODE EAN
SLV133759	LIPSY 50 M COLOR CONTROL	411,75 €	150,00 €	4 0241 63 15042 2

## APPLIQUES ET PLAFONNIERS

### SPOT 79 230V GU10



Référence	Désignation	Prix public € H.T.	Prix promo € H.T.	Couleur	CODE EAN
SLV132021	SPOT 79 230V BLANC GU10	43,80 €	23,00 €	○	4 024163 103411
SLV132024	SPOT 79 230V GRIS GU10	43,80 €	25,00 €	●	4 024163 103428
SLV132020	SPOT 79 230V NOIR GU10	43,80 €	25,00 €	●	4 024163 103404

### CLOCKWORK SINGLE SPOT ALUMINIUM



Référence	Désignation	Prix public € H.T.	Prix promo € H.T.	CODE EAN
PHI531704816	CLOCKWORK SINGLE SPOT ALUMINIUM	60,25 €	34,00 €	8 718291 488149
PHI531724816	CLOCKWORK BAR/TUBE ALUMINIUM 3	104,30 €	59,00 €	8 718291 488163



## APPLIQUES ET PLAFONNIERS

## EUROSPOT LED GRIS 30W



Référence	Désignation	Prix public € H.T.	Prix promo € H.T.	CODE EAN
SLV153814	EUROSPOT LED GRIS 30W	197,55 €	25,00 €	

## MILLENNIUM SPOT WHITE



Référence	Désignation	Prix public € H.T.	Prix promo € H.T.	CODE EAN
PHI531903116	MILLENNIUM SINGLE SPOT WHITE 2	60,25 €	34,00 €	8 718291 488460
PHI531923116	MILLENNIUM BAR/TUBE WHITE 2X4W	104,30 €	62,00 €	8 718291 488484
PHI531943116	MILLENNIUM BAR/TUBE WHITE 4X4W	208,60 €	119,00 €	8 718291 488507

## METRIC WALL LAMP WHITE 2X2W SEL



Référence	Désignation	Prix public € H.T.	Prix promo € H.T.	Couleur	CODE EAN
PHI690878716	METRIC WALL LAMP GREY 2X2W SEL	91,55 €	52,00 €	●	8 717943 744824
PHI690873116	METRIC WALL LAMP WHITE 2X2W SEL	96,38 €	52,00 €	○	8 717943 744817

## APPLIQUES ET PLAFONNIERS

### ECOLED BLC 5 5W/4000K



Référence	Désignation	Prix public € H.T.	Prix promo € H.T.	CODE EAN
ARI50416	ECOLED BLC 5 5W/4000K	17,40 €	9,00 €	3 170070 504160

### PLAFONNIER C4 BLANC 10W/4000K IP44



Référence	Désignation	Prix public € H.T.	Prix promo € H.T.	Couleur	CODE EAN
ARI50429	PLAFONNIER C4 BLANC 10W/4000K IP44	54,45 €	33,00 €	○	3 170070 504290
ARI50436	PLAFONNIER C4 CHROME 10W/4000K IP44	71,85 €	44,00 €	●	3 170070 504368
ARI50437	PLAFONNIER C4 GRIS 21W/4000K IP44	84,60 €	48,00 €	●	3 170070 504375

### APPLIQUE HAWAI LED 8W/3000K



Référence	Désignation	Prix public € H.T.	Prix promo € H.T.	CODE EAN
ARI50163	APPLIQUE FIDJI LED 8W/3000K+++	159,95 €	87,00 €	3 170070 501633



## APPLIQUES ET PLAFONNIERS

## APPLIQUE HAWAI LED 8W/3000K



Référence	Désignation	Prix public € H.T.	Prix promo € H.T.	CODE EAN
ARI50161	APPLIQUE HAWAI LED 8W/3000K	172,70 €	90,00 €	3 170070 501619

## APPLIQUE MOOREA LED 8W/3000K



Référence	Désignation	Prix public € H.T.	Prix promo € H.T.	CODE EAN
ARI50164	APPLIQUE MOOREA LED 8W/3000K	159,95 €	86,00 €	3 170070 501640

## APPLIQUE DOMINO S7-P LED 17W/4000K



Référence	Désignation	Prix public € H.T.	Prix promo € H.T.	CODE EAN
ARI3056	APPLIQUE DOMINO S7-P LED 17W/4000K	135,60 €	72,00 €	3 170070 030560



## APPLIQUES ET PLAFONNIERS

### KALO KR PATERE IP44 A/G9 28W



Référence	Désignation	Prix public € H.T.	Prix promo € H.T.	CODE EAN
ARI3943	KALO KR PATERE IP44 A/G9 28W	80,20 €	38,00 €	3 170070 039433

### PLAFOND FAR IP44



Référence	Désignation	Prix public € H.T.	Prix promo € H.T.	Couleur	CODE EAN
NOV107G-G05X1A-02	PLAFOND FAR IP44 60W E27	23,46 €	15,00 €	●	8 435258 602935
NOV107H-G05X1A-01	PLAFOND FAR IP44 60W E27	24,84 €	15,00 €	○	8 435258 602959

### PLAFOND KIRA IP54 E27

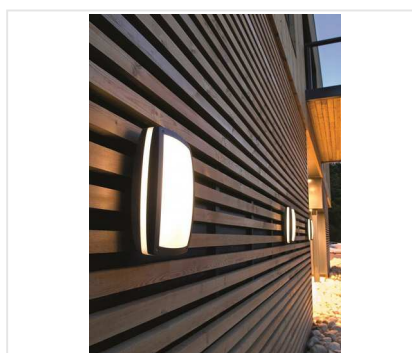

Référence	Désignation	Prix public € H.T.	Prix promo € H.T.	CODE EAN
NOV169A-G05X1A-04	PLAFOND RECTANGULAIRE KIRA IP54 E27 2	69,00 €	39,00 €	8 435256 558487



## APPLIQUES ET PLAFONNIERS

## PLAFOND KIRA IP54



Référence	Désignation	Prix public € H.T.	Prix promo € H.T.	CODE EAN
NOV169C-G05X1A-04	PLAFOND KIRA IP54 E27 2X18W A	93,84 €	49,00 €	8 435256 521085

## PLAFOND TORNADO IP54



Référence	Désignation	Prix public € H.T.	Prix promo € H.T.	CODE EAN
NOV321A-G05X1A-04	PLAFOND TORNADO IP54 E27 75W	114,54 €	59,00 €	8 435256 558463

## PLAFOND BRITTA IP20



Référence	Désignation	Prix public € H.T.	Prix promo € H.T.	CODE EAN
NOV681A-G05X1A-02	PLAFOND BRITTA IP20 E27 60W N	60,72 €	39,00 €	8 435256 542103

## APPLIQUES ET PLAFONNIERS

### APPLIQUE LED THELEDA D SUL AL



Référence	Désignation	Prix public € H.T.	Prix promo € H.T.	CODE EAN
THE1020702	APPLIQUE LED THELEDA D SUL AL 14W	132,60 €	85,00 €	4 003468 101162
THE1020902	APPLIQUE LED THELEDA D SU AL 14W AVEC DÉTECTEUR DE MOUVEMENT	161,50 €	99,00 €	4 003468 101223

### APPLIQUE LED THELEDA D UD AL AVEC DÉTECTEUR DE MOUVEMENT



Référence	Désignation	Prix public € H.T.	Prix promo € H.T.	CODE EAN
THE1020904	APPLIQUE LED THELEDA D UD AL AVEC DÉTECTEUR DE MOUVEMENT	171,40 €	103,00 €	4 003468 101247

### APPLIQUE LED THELEDA D B PLUS AL - DÉTECTEUR DE MOUVEMENT



Référence	Désignation	Prix public € H.T.	Prix promo € H.T.	CODE EAN
THE1020906	APPLIQUE LED THELEDA D B PLUS AL - DÉTECTEUR DE MOUVEMENT	187,55 €	125,00 €	4 003468 101261





## SALLE DE BAIN

## APPLIQUE DE MIROIR DE SALLE DE BAIN



Référence	Désignation	Prix public € H.T.	Prix promo € H.T.	CODE EAN
SMA3000.087	APPLIQUE DE MIROIR DE SALLE DE BAIN	88,90 €	32,00 €	8 711 387 120275

## APPLIQUE DE MIROIR LED



Référence	Désignation	Prix public € H.T.	Prix promo € H.T.	CODE EAN
SMA3000.074	APPLIQUE DE MIROIR DE SALLE DE BAIN	130,08 €	46,00 €	8 711 387 120275

## APPLIQUE TESSA LED



Référence	Désignation	Prix public € H.T.	Prix promo € H.T.	CODE EAN
ARI53052	APPLIQUE TESSA LED 5 W/4000K IP44	88,10 €	48,00 €	3 170070 530527



## SALLE DE BAIN

## DEVIN SIMPLE LED CHROME



**DESTOCKAGE**

Référence	Désignation	Prix public € H.T.	Prix promo € H.T.	CODE EAN
SLV151543	DEVIN SIMPLE LED CHROME	208,50 €	112,00 €	4 0241 63 166041
SLV151553	DEVIN DOUBLE LED CHROME	274,50 €	162,00 €	4 0241 63 166058

## APPLIQUE ET PLAFONNIER VAYNISSA LED



**DESTOCKAGE**

Référence	Désignation	Prix public € H.T.	Prix promo € H.T.	CODE EAN
SLV149701	VAYNISSA BLANC LED 4X 4 4W	208,50 €	106,00 €	4 0241 63 157384
SLV149702	VAYNISSA CHROME LED 4X 4 4W	219,50 €	112,00 €	4 0241 63 156486

## APPLIQUE LED



**DESTOCKAGE**

Référence	Désignation	Prix public € H.T.	Prix promo € H.T.	CODE EAN
SMA3000.068	APPLIQUE DE SALLE DE BAIN ORIENTABLE	65,95 €	25,00 €	8 711387 120084

## SALLE DE BAIN

## APPLIQUE LED



**DESTOCKAGE**

Référence	Désignation	Prix public € H.T.	Prix promo € H.T.	CODE EAN
SMA3000.069	APPLIQUE DE SALLE DE BAIN	126,05 €	48,00 €	8 711 387 12009 1

## APPLIQUE MIROIR NIKA IP44 A/LPE G9 25W



**DESTOCKAGE**

Référence	Désignation	Prix public € H.T.	Prix promo € H.T.	CODE EAN
ARI4715	NIKA MIROIR IP44 A/LPE G9 25W	138,15 €	66,00 €	3 170070 047155

## APPLIQUE MURALE HOTSTONE WALL LAMPE LED CHROME



**DESTOCKAGE**

Référence	Désignation	Prix public € H.T.	Prix promo € H.T.	CODE EAN
PHI340491116	HOTSTONE WALL LAMPE LED CHROME	110,10 €	62,00 €	8 718291 455325
PHI340501116	HOTSTONE WALL LAMPE LED CHROME	219,60 €	117,00 €	8 718291 455448



## SALLE DE BAIN

## APPLIQUE ORIENTABLE LED



Référence	Désignation	Prix public € H.T.	Prix promo € H.T.	CODE EAN
SMA10.002.89	APPLIQUE DE SALLE DE BAIN ORIENTABLE	96,59 €	37,00 €	8 711387 120206

## APPLIQUE TRUKKO MIROIR MURAK IP44



Référence	Désignation	Prix public € H.T.	Prix promo € H.T.	CODE EAN
SLV149752	TRUKKO MIROIR MURAL IP44	384,30 €	177,00 €	4 024163 156226

## APPLIQUE VISSARDO MURAL IP44



Référence	Désignation	Prix public € H.T.	Prix promo € H.T.	CODE EAN
SLV149782	VISSARDO MIROIR MURAL IP44	219,50 €	118,00 €	4 024163 156257



## SALLE DE BAIN

### MIROIR À POSER VISSARDO



Référence	Désignation	Prix public € H.T.	Prix promo € H.T.	CODE EAN
SLV149792	VISSARDO MIROIR À POSER	219,50 €	112,00 €	4 0241 63 156264

### FIT APPLIQUE MURALE CHROME



Référence	Désignation	Prix public € H.T.	Prix promo € H.T.	CODE EAN
PHI340581116	FIT WALL LAMPE LED CHROME 2X2.6	95,05 €	55,00 €	8 718291 455349
PHI340591116	FIT WALL LAMPE LED CHROME 3X2.6	121,70 €	70,00 €	8 718291 455424

### KIT SDB IP65 9W850



Référence	Désignation	Prix public € H.T.	Prix promo € H.T.	Couleur	CODE EAN
LUM195B	KIT SDB IP65 9W850 BLANC	60,00 €	14,00 €	○	3 700005 319547
LUM195ABR	KIT SDB IP65 9W850 ALU BROSSÉ	72,00 €	14,00 €	●	3 700005 319516

## SALLE DE BAIN

## RÉGLETTES LED TALASSO LED



Référence	Désignation	Prix public € H.T.	Prix promo € H.T.	CODE EAN
ARI53067	TALASSO SIMPLE LED 6W/4000K	43,60 €	24,00 €	 3 1 70070 53067 1
ARI53068	TALASSO INTER LED 6W/4000K	45,55 €	25,00 €	 3 1 70070 53068 8
ARI53069	TALASSO PC+INTER LED 6W/4000K	52,05 €	26,00 €	 3 1 70070 53069 5
ARI53070	TALASSO PC-R+INTER LED6W/4000K	76,15 €	39,00 €	 3 1 70070 53070 1



## RUBAN LED

## PACK BE GOOD 1-5X1M DIFF/CLIPS/



Référence	Désignation	Prix public € H.T.	Prix promo € H.T.	CODE EAN
EUR89905	PACK BE GOOD 1-5X1M DIFF/CLIPS/	76,75 €	46,00 €	 9 000100 000611

## PACK PROFIL SLIDE R AL 5X1M

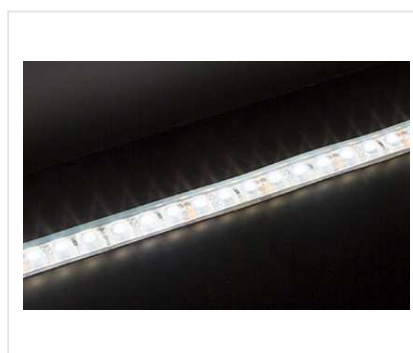

Référence	Désignation	Prix public € H.T.	Prix promo € H.T.	CODE EAN
EUR89903	PACK PROFIL SLIDE R AL 5X1M	76,75 €	46,00 €	 9 000100 000611

## PACK SUPER SOFT PRO 4000K 5M



Référence	Désignation	Prix public € H.T.	Prix promo € H.T.	CODE EAN
EUR42711	PACK SUPER SOFT PRO 4000K 5M	166,40 €	100,00 €	 9 000100 000611

# RUBAN LED

PACK S/SOFT 3M 4000K 5W/M



Référence	Désignation	Prix public € H.T.	Prix promo € H.T.	CODE EAN
EUR42001	PACK S/SOFT 3M 4000K 5W/M	83,15 €	50,00 €	9 0001 00 0006 11

LONGFLEX 4000K 510LM/M 230V - 10W/M



Référence	Désignation	Prix public € H.T.	Prix promo € H.T.	CODE EAN
EUR425611	LONGFLEX 4000K 510LM/M 230V	51,10 €	26,00 €	9 0001 00 0005 74

SMART 20-60VA - IP 68 - CÂBLE ENTRÉE / SORTIE



Référence	Désignation	Prix public € H.T.	Prix promo € H.T.	CODE EAN
EUR7929	SMART 20-60VA - IP 68 - CÂBLE ENTRÉE / SORTIE	51,10 €	26,00 €	9 100000 0001 14

## RUBAN LED

## KIT CONNEXION LONGFLEX 15W/M



Référence	Désignation	Prix public € H.T.	Prix promo € H.T.	CODE EAN
EUR42551	KIT CONNEXION LONGFLEX 15W/M	25,50 €	13,00 €	9 100000 000107

## FLEXE240™ - KIT DE RUBAN LED IP65 INTERCONNECTABLE 240V 2

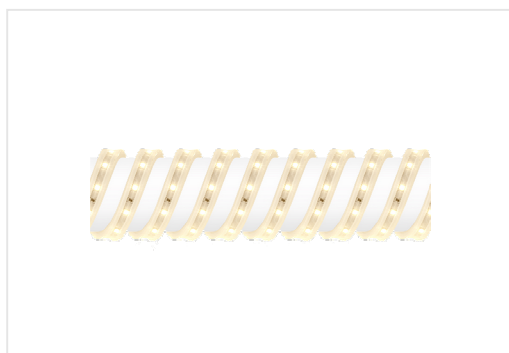

Référence	Désignation	Prix public € H.T.	Prix promo € H.T.	Couleur	CODE EAN
AURENSTKM240	RUBAN LED 230V 24W 4000K 2 MÈTRES	30,50 €	16,00 €	○	5 055155 401009
AURENSTKM2BLU	RUBAN LED 230V 24W BLEU 2 MÈTRES	30,50 €	16,00 €	●	5 055155 401016

## CORDON D'ALIMENTATION POUR RUBAN LED



Référence	Désignation	Prix public € H.T.	CODE EAN
AURENSTPEU	CORDON D'ALIMENTATION POUR RUBAN LED	9,75 €	3 609640 129330

## RUBAN LED

### KIT FLEXO LED 120 2400K / 2,5M



Référence	Désignation	Prix public € H.T.	Prix promo € H.T.	CODE EAN
ARI55243	KIT FLEXO LED 120 2400K / 2,5M	122,85 €	60,00 €	3 170070 552437

### CLIPS DE FIXATION INOX LONGFLEX 15W/M



Référence	Désignation	Prix public € H.T.	Prix promo € H.T.	CODE EAN
EUR42558	CLIPS DE FIXATION INOX LONGFLEX 15W/M	31,90 €	17,00 €	9 100000 000107







## SOLAIRE

## SOLAIRE

## LAMPE SOLAIRE AUTONOME POUR PILLIERS ET POTEAUX



Référence	Désignation	Prix public € H.T.	Prix promo € H.T.	CODE EAN
SOL2012	2012 BOULE 520MM NOIRE	189,23 €	111,00 €	3 700969 600309

## BORNE INOX 380MM



Référence	Désignation	Prix public € H.T.	Prix promo € H.T.	Couleur	CODE EAN
SOL260238IN	2602-38I BORNE INOX NOIRE 380MM	209,55 €	114,00 €	●	9 000100 000598
SOL260238I	2602-38I BORNE INOX 380MM	209,55 €	120,00 €	●	3 700969 600118
SOL2602MB	2602-MB APPLIQUE MURALE BLANC 380MM	215,90 €	127,00 €	○	3 700969 600187
SOL2602MI	2602-MI APPLIQUE MURALE INOX 380MM	215,90 €	127,00 €	●	3 700969 600170
SOL260290IB	2602-90B BORNE INOX BLANC 900MM	228,60 €	143,00 €	○	3 700969 600149
SOL260290I	2602-90I BORNE INOX 900MM	228,60 €	143,00 €	●	3 700969 600132



## SOLAIRE

## ENCASTRÉ DE SOL



Référence	Désignation	Prix public € H.T.	Prix promo € H.T.	Couleur	CODE EAN
SOL3210W	3210W ENCASTRE DE SOL WHITE	120,65 €	71,00 €	○	3 700969 60023 1

## APPLIQUE INCLINÉE SOLAIRE AVEC DÉTECTEUR



Référence	Désignation	Prix public € H.T.	Prix promo € H.T.	CODE EAN
SMA5000.701	APPLIQUE INCLINÉE SOLAIRE AVEC DÉTECTEUR	57,32 €	22,00 €	8 711 387 16996 0

## APPLIQUE SOLAIRE LED



Référence	Désignation	Prix public € H.T.	Prix promo € H.T.	CODE EAN
SMAGWS-003-DS	APPLIQUE SOLAIRE LED 89 MM	39,97 €	15,00 €	8 711 387 08358 7
SMA10.030.77	APPLIQUE SOLAIRE LED 89 MM (INCLINÉ + DIFFUSEUR)	39,97 €	15,00 €	8 711 387 08358 7
SMAGWS-001-DS	APPLIQUE MURALE LED SOLAIRE	40,96 €	16,00 €	8 711 387 15277 1

## SOLAIRE

## BORNE BLANCHE H380MM POUR ÉCLAIRAGE ET BALISAGE



Référence	Désignation	Prix public € H.T.	Prix promo € H.T.	CODE EAN
SOLB00738B	BORNE BLANCHE H380MM POUR ECLAIRAGE ET BALISAGE	209,55 €	131,00 €	3 700969 600019
SOLB00790I	BORNE INOX H900MM POUR ECLAIRAGE ET BALISAGE	228,60 €	136,00 €	3 700969 600033

## BORNE ALU NOIR H800MM



Référence	Désignation	Prix public € H.T.	Prix promo € H.T.	CODE EAN
SOLCP06N	CP06N BORNE ALU NOIR H800MM	254,00 €	149,00 €	3 700969 600217

## LAMPADAIRE HY005 6 W



Référence	Désignation	Prix public € H.T.	Prix promo € H.T.	CODE EAN
SOLHY0005	LAMPADAIRE HY005 6 W	380,00 €	83,00 €	9 000100 000598

## SOLAIRE

## LAMPE 2602-90N



**DESTOCKAGE**

Référence	Désignation	Prix public € H.T.	Prix promo € H.T.	CODE EAN
SOL260290N	LAMPE 2602-90N	228,60 €	117,00 €	9 0001 00 000598

## LU6NM01MAT - MAT LAMPADAIRE NM



Référence	Désignation	Prix public € H.T.	Prix promo € H.T.	CODE EAN
SOLNM01MAT	LU6NM01MAT - MAT LAMPADAIRE NM	355,60 €	175,00 €	9 0001 00 000604

## ROCHER SOLAIRE NAXOS



Référence	Désignation	Prix public € H.T.	Prix promo € H.T.	CODE EAN
SMA10.009.37	ROCHER SOLAIRE NAXOS	20,61 €	8,00 €	8 711387 052514

## SOLAIRE

## LANTERNE SOLAIRE 15W 1600LM



Référence	Désignation	Prix public € H.T.	Prix promo € H.T.	CODE EAN
XPE40071	LANTERNE SOLAIRE 15W 1600LM	159,00 €	99,00 €	9 0001 00 000628

## PROJECTEUR LED SOLAIRE



Référence	Désignation	Prix public € H.T.	Prix promo € H.T.	CODE EAN
XPE40067	PROJECTEUR LED SOLAIRE 3,2W -	82,00 €	35,00 €	9 000050 000006
XPE40068	PROJECTEUR LED SOLAIRE 6,8W -	145,00 €	59,00 €	9 200000 000517

## SPOT DE SOL SOLAIRE ROND



Référence	Désignation	Prix public € H.T.	Prix promo € H.T.	CODE EAN
SMA5000.389	SPOT DE SOL SOLAIRE ROND	16,58 €	7,00 €	8 711387 095719



## SOLAIRE

## SPOT SOLAIRE ENCASTRABLE CARLO CARRÉ



Référence	Désignation	Prix public € H.T.	Prix promo € H.T.	CODE EAN
SMA10.009.62	SPOT SOLAIRE ENCASTRABLE CARLO	19,47 €	7,00 €	 8 711 387 093753

## SPOT SOLAIRE ENCASTRABLE CARLO ROND



Référence	Désignation	Prix public € H.T.	Prix promo € H.T.	CODE EAN
SMA10.009.61	SPOT SOLAIRE ENCASTRABLE CARLO	18,56 €	8,00 €	 8 711 387 093746

## ACCESSOIRES

### BARRE LED AVEC INTERRUPTEUR



Référence	Désignation	Prix public € H.T.	Prix promo € H.T.	CODE EAN
SMA7000.061	BARRE LED AVEC INTERRUPTEUR	69,32 €	25,00 €	 8 711 387 374135

### DÉTECTEUR D'OBSTACLE



Référence	Désignation	Prix public € H.T.	Prix promo € H.T.	CODE EAN
SMA7000.047	DÉTECTEUR D'OBSTACLE	20,17 €	8,00 €	 8 711 387 373985
SMA7000.048	DÉTECTEUR DE PROXIMITÉ	20,17 €	8,00 €	 8 711 387 373992

### DOUILLE GU5.3



Référence	Désignation	Prix public € H.T.	Prix promo € H.T.	CODE EAN
ORB126941	DOUILLE GU5.3	5,00 €	2,00 €	 9 100000 000114

## ACCESSOIRES

## DOUILLE GU10 TRIPLE BORNIER RAPIDE



Référence	Désignation	Prix public € H.T.	Prix promo € H.T.	CODE EAN
EURDRGU53	DOUILLE GU5.3 DOUBLE BORNIER RAPIDE	5,40 €	3,00 €	9 200000 000524
EURDRGU10	DOUILLE GU10 TRIPLE BORNIER RAPIDE	6,55 €	4,00 €	9 100000 000114

## ÉCLAIRAGE LED DE PLACARD



Référence	Désignation	Prix public € H.T.	Prix promo € H.T.	CODE EAN
SMA7000.020	ÉCLAIRAGE LED DE PLACARD	39,56 €	15,00 €	8 711387 373718
SMA7000.019	KIT DE 2 ÉCLAIRAGES LED DE PLACARD	102,70 €	37,00 €	8 711387 373701

## JEU D'INTERRUPTEUR INTELLIGENT + TÉLÉCOMMANDE



Référence	Désignation	Prix public € H.T.	Prix promo € H.T.	CODE EAN
SMASH5-SET-GW-F	KIT DE CONTROLE INTERRUPTEURS DOMOTIQUE	131,14 €	50,00 €	8 711658 410708



## ACCESSOIRES

### KIT 2 PRISES EXTERIOR + TÉLÉCOMMANDE



Référence	Désignation	Prix public € H.T.	Prix promo € H.T.	CODE EAN
SMASF-500WD/2F	KIT 2 PRISES EXTERIOR + TÉLÉCOMMANDE	34,81 €	14,00 €	8 711 658 410753

### KIT 3 PRISES INTERIOR + TÉLÉCOMMANDE



Référence	Désignation	Prix public € H.T.	Prix promo € H.T.	CODE EAN
SMASF-500/3F	KIT 3 PRISES INTERIOR + TÉLÉCOMMANDE	28,84 €	11,00 €	8 711 658 410746

### TRANSFORMATEUR ÉLECTRONIQUE DIMMABLE LED & HALOGÈNE



Référence	Désignation	Prix public € H.T.	Prix promo € H.T.	CODE EAN
LUM9921	TRANSFO ELEC DIM 3-70W CABLE	9,90 €	6,00 €	3 700005 399211

## ACCESSOIRES

## CONVERTISSEUR ÉLECTRONIQUE 2X30W IP66 12VDC



Référence

EUR4212060

Désignation

CONVERTISSEUR ÉLECTRONIQUE  
2X30W IP66 12VDC

Prix public € H.T.

95,95 €

Prix promo € H.T.

79,00 €

CODE EAN





## SOURCES

## LED 1,5WE27 B-C STARRY ÉTOILE



**DESTOCKAGE**

Référence	Désignation	Prix public € H.T.	Prix promo € H.T.	CODE EAN
SMALSO-04051	LED 1,5WE27 B-C STARRY ÉTOILE	14,99 €	5,21 €	8 711 387 155147
SMALSO-04061	LED 1,5WE27 COUL.STARRY ÉTOILE	14,99 €	5,21 €	8 711 387 155161

## LED 1,5WE27 B-C STARRY COEUR



Référence	Désignation	Prix public € H.T.	Prix promo € H.T.	CODE EAN
SMALSO-04031	LED 1,5WE27 B-C STARRY COEUR	14,99 €	5,28 €	8 711 387 155109

## LED 1,5WE27 B-C STARRY GLOBE



Référence	Désignation	Prix public € H.T.	Prix promo € H.T.	CODE EAN
SMALSO-04011	LED 1,5WE27 B-C STARRY GLOBE	14,99 €	6,00 €	8 711 387 155062
SMALSO-04021	LED 1,5WE27 COUL.STARRY GLOBE	14,99 €	6,00 €	8 711 387 155086

## SOURCES

## LED 3,5W 3D GLOBE E27



**DESTOCKAGE**

Référence	Désignation	Prix public € H.T.	Prix promo € H.T.	CODE EAN
SMALSO-04091	LED 3,5W 3D GLOBE E27	14,99 €	7,00 €	 8 711387 155222
SMALSO-04101	LED 3,5W 3D GLOBE E27	19,99 €	9,00 €	 8 711387 155246

## LED 3,5W 3D ST64 E27



Référence	Désignation	Prix public € H.T.	Prix promo € H.T.	CODE EAN
SMALSO-04081	LED 3,5W 3D ST64 E27	9,99 €	4,99 €	 8 711387 155208

## LED 3,5W 3D STD E27



Référence	Désignation	Prix public € H.T.	Prix promo € H.T.	CODE EAN
SMALSO-04071	LED 3,5W 3D STD E27	8,99 €	4,70 €	 8 711387 155185



## SOURCES

## LED E14 2,5W B-C OR



Référence	Désignation	Prix public € H.T.	Prix promo € H.T.	CODE EAN
SMA10.100.09	LED E14 2,5W B-C OR CANDLE	9,49 €	4,00 €	 8 711 387 154287
SMA10.100.12	LED E14 2,5W B-C OR GLOBE	9,49 €	4,00 €	 8 711 387 154379
SMA10.100.14	LED E27 2,5W B-C OR A60	12,49 €	4,47 €	 8 711 387 154430

## LED E27 2,5W B-C OR





**DESTOCKAGE**

Référence	Désignation	Prix public € H.T.	Prix promo € H.T.	CODE EAN
SMA10.100.16	LED E27 2,5W B-C OR ST64	13,99 €	5,57 €	 8 711 387 154492
SMA10.100.18	LED E27 2,5W B-C OR GLOBE	18,99 €	9,00 €	 8 711 387 154553
SMA10.100.22	LED E27 2,5W B-C OR TUBE	18,99 €	9,00 €	 8 711 387 154676

## SOURCES

## SPHÈRE LED EG 827 6W



Référence	Désignation	Prix public € H.T.	Prix promo € H.T.	CODE EAN
GEL93030263	E14G 827 6W SPHÈRE LED	8,50 €	5,25 €	 00000000000000
GEL93030265	E27G 827 6W SPHÈRE LED	8,50 €	4,29 €	 00000000000000

## CLA LEDLUSTER ND 2-25W P45 E27



Référence	Désignation	Prix public € H.T.	Prix promo € H.T.	CODE EAN
PHI574157	CLA LEDLUSTER ND 2-25W P45 E27	8,55 €	4,60 €	 8 718696 574157

## FIL LED G80 827 6.5W



Référence	Désignation	Prix public € H.T.	Prix promo € H.T.	CODE EAN
GEL93052991	G80 827 6.5W FIL LED	21,20 €	10,00 €	 00000000000000



## SOURCES

## LED FIL HELIAX GLOBE



Référence	Désignation	Prix public € H.T.	Prix promo € H.T.	CODE EAN
GEL93078643	LED FIL HELIAX GLOBE 80 5.5W	20,93 €	13,00 €	0000000000000
GEL93078645	LED FIL HELIAX GLOBE 95 5.5W	24,20 €	15,00 €	0 064894 585104

## LED FIL HELIAX CANDLE 3.5W



Référence	Désignation	Prix public € H.T.	Prix promo € H.T.	CODE EAN
GEL93078636	LED FIL HELIAX CANDLE 3.5W	10,95 €	7,00 €	0 064894 585050

## LED FIL HELIAX PEAR 5.5W



Référence	Désignation	Prix public € H.T.	Prix promo € H.T.	CODE EAN
GEL93078647	LED FIL HELIAX PEAR 5.5W	19,29 €	12,00 €	0 064894 585074



## SOURCES

## FLAMLED E14G 827 6W



Référence	Désignation	Prix public € H.T.	Prix promo € H.T.	CODE EAN
GEL93030251	E14G 827 6W FLAMLED CLAIRE	8,50 €	6,00 €	
GEL93030252	E14G 827 6W FLAMLED OPALE	7,85 €	6,00 €	

## LED E27 827 10W A60



Référence	Désignation	Prix public € H.T.	Prix promo € H.T.	CODE EAN
GEL93063992	E27 827 10W A60 LED	4,09 €	3,00 €	
GEL93063993	B22 827 10W A60 LED	4,09 €	3,00 €	

## LEDSTICK E27 830 ET 865



Référence	Désignation	Prix public € H.T.	Prix promo € H.T.	CODE EAN
GEL93064014	E27 830 6W LEDSTICK	3,76 €	3,00 €	



## SOURCES

## LEDSTICK E27 830 ET 865



Référence	Désignation	Prix public € H.T.	Prix promo € H.T.	CODE EAN
GEL93064016	E27 865 6W LEDSTICK	3,76 €	3,00 €	000000000000
GEL93064026	E27 865 12W LEDSTICK	5,01 €	4,00 €	0 064894 573965
GEL93064029	E27 830 15W LEDSTICK	5,72 €	6,00 €	000000000000
GEL93064031	E27 865 15W LEDSTICK	7,36 €	4,44 €	0 064894 574016
GEL93104348	E27 865 LED DIMSTIK 14(100)	7,36 €	4,00 €	9 000100 000628
GEL93024034	E27 865 10W LEDSTICK X1	10,25 €	4,00 €	000000000000
GEL93068471	E27 830 9W LEDSTICK	12,91 €	4,00 €	000000000000
GEL93092682	DALLE LED 865 UGR19 PACK DE 2	120,00 €	34,90 €	2 006489 450037

## COREPRO LED STICK ND 9.5-75W T



Référence	Désignation	Prix public € H.T.	Prix promo € H.T.	CODE EAN
PHI814536	COREPRO LED STICK ND 9.5-75W T	7,38 €	5,37 €	8 718696 814536

## SOURCES

## E14 830 ET 865 LED BRIGHTSTIK 7W



Référence	Désignation	Prix public € H.T.	Prix promo € H.T.	CODE EAN
GEL93047728	E14 865 LED BRIGHTSTIK 7W	4,25 €	2,51 €	 00000000000000
GEL93047729	E14 830 LED BRIGHTSTIK 7W	4,25 €	2,51 €	 00000000000000

## E27 865 LED GLASS A60 8W(60)



Référence	Désignation	Prix public € H.T.	Prix promo € H.T.	CODE EAN
GEL93074736	E27 865 LED GLASS A60 8W(60)	4,58 €	2,51 €	 9 0001 00 0006 1 1

## E27 827 LED GLASS A67 10W(75)



Référence	Désignation	Prix public € H.T.	Prix promo € H.T.	CODE EAN
GEL93081799	E27 827 LED GLASS A67 10W(75)	6,54 €	3,82 €	 00000000000000



## SOURCES

## LED GLASS A67 13W(100) 865 E27



Référence	Désignation	Prix public € H.T.	Prix promo € H.T.	CODE EAN
GEL93081804	LED GLASS A67 13W(100) 865 E27	8,99 €	4,74 €	 9 200000 000517



## LED GLASS E27 840 8W A60



Référence	Désignation	Prix public € H.T.	Prix promo € H.T.	CODE EAN
GEL93059798	E27 840 8W A60LED GLASS	4,58 €	4,00 €	 000000000000

## MZD LED 40W A60 E27 840 FR ND





Référence	Désignation	Prix public € H.T.	Prix promo € H.T.	CODE EAN
PHI161436	MZD LED 40W A60 E27 840 FR ND	4,10 €	3,00 €	 3 139188 161436
PHI161474	MZD LED 60W A60 E27 840 FR ND	4,10 €	3,00 €	 3 139188 161474
PHI161511	MZD LED 75W A60 E27 840 FR ND	5,17 €	4,00 €	 3 139188 161511

## SOURCES

MZD LED 40W A60 E27 840 FR ND



Référence	Désignation	Prix public € H.T.	Prix promo € H.T.	CODE EAN
PHI161658	MZD LED 65W GU10 840 36D ND 1C	5,49 €	4,00 €	 3 139188 161658
PHI161559	MZD LED 100W A67 E27 CW FR ND	7,46 €	4,97 €	 3 139188 161559

LED SSW 60W A60 E27 WW-CW FR N



Référence	Désignation	Prix public € H.T.	Prix promo € H.T.	CODE EAN
PHI588840	LED SSW 60W A60 E27 WW FR ND 1	11,75 €	9,00 €	 8 718696 588840

GU10G 830 5,5W LED DIM





Référence	Désignation	Prix public € H.T.	Prix promo € H.T.	CODE EAN
GEL93068475	GU10G 830 5,5W LED DIM	6,54 €	3,95 €	 000000000000



## SOURCES

LED GU10 865 5W LED 35°



Référence	Désignation	Prix public € H.T.	Prix promo € H.T.	CODE EAN
GEL93067828	GU10 865 5W LED 35°	3,76 €	3,00 €	 0 064894 585630
GEL93040552	LED 6W GU10 940 25 GRADABLE	8,83 €	5,30 €	 0000000000000

MAS LED SPOT VLE D 4.9-50W GU1



Référence	Désignation	Prix public € H.T.	Prix promo € H.T.	CODE EAN
PHI707890	MAS LED SPOT VLE D 4.9-50W GU1	11,40 €	7,58 €	 8 718696 707890

LPE GU10 4,6W 840 36°



Référence	Désignation	Prix public € H.T.	Prix promo € H.T.	CODE EAN
PHI728390	LPE GU10 4,6W 840 36°	7,25 €	4,00 €	 8 718696 728390

## SOURCES

## PISCINE LED PAR56 16W (300) 7

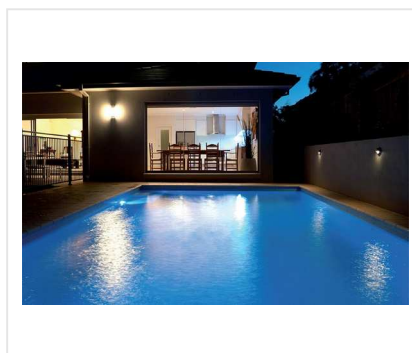

Référence	Désignation	Prix public € H.T.	Prix promo € H.T.	CODE EAN
GEL93061072	PISCINE LED PAR56 16W (300) 7	82,13 €	59,00 €	1 006489 458058

## CAPSULE LED G9 827 2,5W



Référence	Désignation	Prix public € H.T.	Prix promo € H.T.	CODE EAN
GEL93019427	G9 827 2,5W CAPSULE LED	6,87 €	4,09 €	8 718696 728390

## AMPOULE LED R7SLED J118 R7SLED



Référence	Désignation	Prix public € H.T.	Prix promo € H.T.	CODE EAN
LUM2013	J118 R7SLED 10W 1000LM 4K	42,00 €	14,00 €	3 700005 320130



## SOURCES

E27 830 15W PAR38



Référence	Désignation	Prix public € H.T.	Prix promo € H.T.	CODE EAN
GEL93044739	E27 830 15W PAR38	29,43 €	19,00 €	 00000000000000

LED 80W/HID/740/E40



Référence	Désignation	Prix public € H.T.	Prix promo € H.T.	CODE EAN
GEL93067075	E40 740 80W HID LED	225,63 €	126,00 €	 00000000000000

MERCURY LED E27 740 35W



Référence	Désignation	Prix public € H.T.	Prix promo € H.T.	CODE EAN
GEL93038711	E27 740 35W MERCURY LED	94,83 €	49,00 €	 00000000000000



## SOURCES

## LINOLITE LED10W 800LM 840



Référence	Désignation	Prix public € H.T.	Prix promo € H.T.	CODE EAN
LUM3401	LINOLITE LED10W 800LM 840	28,00 €	9,50 €	3 700005 334014

## COREPRO LEDCAPSULE ND 1.9-25W



Référence	Désignation	Prix public € H.T.	Prix promo € H.T.	CODE EAN
PHI713921	COREPRO LEDCAPSULE ND 1.9-25W	14,10 €	9,77 €	8 718696 713921

## COREPRO LEDCAPSULE ND 3.2-40W



Référence	Désignation	Prix public € H.T.	Prix promo € H.T.	CODE EAN
PHI815267	COREPRO LEDCAPSULE ND 3.2-40W	15,60 €	11,03 €	8 718696 815267



## SOURCES

## MASTERCOLOUR CDM-E MW ECO 230W



Référence	Désignation	Prix public € H.T.	Prix promo € H.T.	CODE EAN
PHI596647	MASTERCOLOUR CDM-E MW ECO 230W	88,80 €	68,69 €	8 718696 596647

## MASTER PL-C 13W/827/2P 1CT/5X



Référence	Désignation	Prix public € H.T.	Prix promo € H.T.	CODE EAN
PHI620866	MASTER PL-C 13W/840/2P 1CT/5X	5,95 €	3,88 €	8 711500 620866

## MASTER TL5 HE 28W/865 SLV/40



Référence	Désignation	Prix public € H.T.	Prix promo € H.T.	CODE EAN
PHI710154	MASTER TL5 HE 28W/865 SLV/40	7,45 €	2,59 €	8 711500 710154
PHI710185	MASTER TL5 HE 35W/865 SLV/40	8,15 €	4,53 €	8 711500 710185
PHI716422	MST TL MINI 8W/840 FAM/10X25B	10,85 €	6,93 €	8 711500 716422

## SOURCES

## MASTER TL-D SUPER 80 18W/840



Référence	Désignation	Prix public € H.T.	Prix promo € H.T.	CODE EAN
PHI631718	MASTER TL-D SUPER 80 18W/840	3,33 €	1,78 €	8 711 500 631718
PHI631770	MASTER TL-D SUPER 80 18W/865	3,33 €	1,89 €	8 711 500 631770
PHI632012	MASTER TL-D SUPER 80 36W/840	3,73 €	1,88 €	8 711 500 632012
PHI632074	MASTER TL-D SUPER 80 36W/865	3,73 €	2,12 €	8 711 500 632074
PHI632197	MASTER TL-D SUPER 80 58W/840	4,05 €	2,83 €	8 711 500 632197
PHI632258	MASTER TL-D SUPER 80 58W/865	4,05 €	2,28 €	8 711 500 632258

## MASTER TL5 HE 14W/840 1SL/20



Référence	Désignation	Prix public € H.T.	Prix promo € H.T.	CODE EAN
PHI639400	MASTER TL5 HE 14W/840 1SL/20	4,44 €	2,46 €	8 711 500 639400
PHI639486	MASTER TL5 HE 28W/840 1SL/20	5,10 €	2,60 €	8 711 500 639486



## SOURCES

## MASTER TL5 HO 54W/840 SLV/20



Référence	Désignation	Prix public € H.T.	Prix promo € H.T.	CODE EAN
PHI643186	MASTER TL5 HO 54W/840 SLV/20	4,88 €	2,51 €	8 711 500 643186
PHI639646	MASTER TL5 HO 39W/840 SLV/20	7,45 €	2,71 €	8 711 500 639646
PHI643162	MASTER TL5 HO 54W/830 SLV/20	7,65 €	3,13 €	8 711 500 643162
PHI643919	MASTER TL5 HO 54W/865 SLV/40	7,65 €	3,17 €	8 711 500 643919
PHI643896	MASTER TL5 HO 49W/865 SLV/40	8,35 €	2,73 €	8 711 500 643896

## LAMPE LED GU10 3W 38 RGBW BLU



Référence	Désignation	Prix public € H.T.	Prix promo € H.T.	CODE EAN
EUR406338	LAMPE LED GU10 3W 38 RGBW BLU	25,60 €	19,00 €	9 500000 000051

# LANTERNES

## LUXÈTRE PORTABLE



Référence	Désignation	Prix public € H.T.	Prix promo € H.T.	CODE EAN
CHAP01654110	CA1110 LUXÈTRE PORTABLE	513,45 €	329,00 €	 3 663653 000963

## LUMISTREET MEDIUM BGP253 ECO94/740 II DM 48/60S



Référence	Désignation	Prix public € H.T.	Prix promo € H.T.	CODE EAN
PHIBGP253-94	BGP253 ECO94/740 II DM 48/60S	439,00 €	255,00 €	 9 000100 000598

## NELLA 100W E27



Référence	Désignation	Prix public € H.T.	Prix promo € H.T.	CODE EAN
THO96257119	NELLA NUE AVEC DOUILLE E27	249,00 €	169,00 €	 9 000100 000604

## LANTERNES

## LUMINAIRE TECHNIQUE À PLAQUE DE RECOUVREMENT - ONTRIA



Référence	Désignation	Prix public € H.T.	Prix promo € H.T.	CODE EAN
TRI6928940	ONTRIA I AB17L/6200-740 G1 ET	470,00 €	280,00 €	4 018242 379736
TRI6929040	ONTRIA II AB17L/9100-740 G1 ET	574,00 €	342,00 €	4 018242 379743

## ADAPTATEUR ONTRIA DIAMÈTRE 60



Référence	Désignation	Prix public € H.T.	Prix promo € H.T.	CODE EAN
TRI6930300	ONTRIA MB/60	40,00 €	26,00 €	4 018242 379873

## ISARO MA34-42



Référence	Désignation	Prix public € H.T.	Prix promo € H.T.	CODE EAN
THO96261772	ISARO MA34-42	21,00 €	10,69 €	3 607640 180313
THO96262903	ISARO 100W HID 230V CL2 EFL MA	275,95 €	153,43 €	3 607640 201445

## LANTERNES

### SKAT LANTERNE EP 32W WDL



Référence	Désignation	Prix public € H.T.	Prix promo € H.T.	CODE EAN
<b>SIM284-YYY390013</b>	SKAT LANTERNE EP 32W WDL	<b>331,67 €</b>	<b>199,00 €</b>	

### SUPPORT DE PROJECTEUR



Référence	Désignation	Prix public € H.T.	Prix promo € H.T.	CODE EAN
<b>SIFSUPPROJPC</b>	SUPPORT DE PROJECTEUR PERMET LA FIXATION DE 1 À 4 PROJECTEUR	<b>220,00 €</b>	<b>120,00 €</b>	

### NATH LANTERNE EP 81W 3000K



Référence	Désignation	Prix public € H.T.	Prix promo € H.T.	CODE EAN
<b>SIM103-YYY386016</b>	NATH LANTERNE EP 81W 3000K	<b>465,00 €</b>	<b>279,00 €</b>	



## LANTERNES

## BOÎTIER TYPE 597 CLASSE II



Référence	Désignation	Prix public € H.T.	Prix promo € H.T.	CODE EAN
DEP59700102N	BOÎTIER TYPE 597 CLASSE II NOIR - 1 COUPE-CIRCUIT PH+N + FUSIBLE 2A (1)	15,90 €	11,00 €	

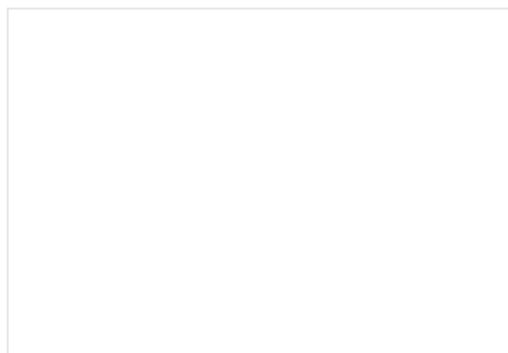

## MAT

BOÎTIER TYPE 0 CLASSE II ORNES 2X16 MM<sup>2</sup>

Référence	Désignation	Prix public € H.T.	Prix promo € H.T.	CODE EAN
DEP67405800	BOÎTIER TYPE 0 CLASSE II IVOIRE ORNES 2X16 MM <sup>2</sup>	39,75 €	29,00 €	9 000000 500808

## CROSSE EP200 42 1000

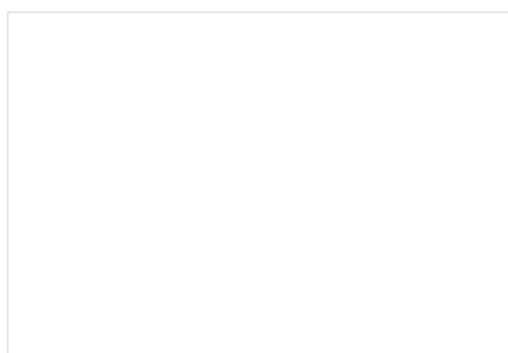

Référence	Désignation	Prix public € H.T.	Prix promo € H.T.	CODE EAN
SIFEP20042100005	CROSSE EP200 42 1000 5°	36,00 €	25,00 €	9 000006 000210
SIFEP20042100020	CROSSE EP200 42 1000 20°	36,00 €	25,00 €	9 000006 000210

## EMBOUT PIPE DOUBLE

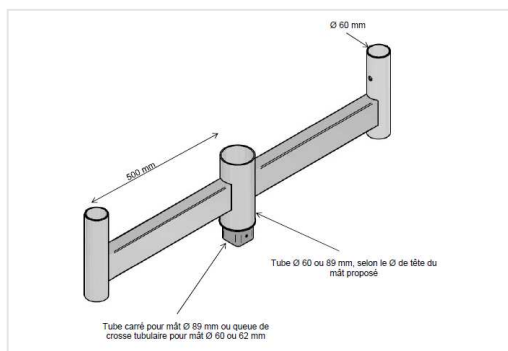

Référence	Désignation	Prix public € H.T.	Prix promo € H.T.	CODE EAN
PET7101485903	EMBOUT PIPE DOUBLE EMB. PIP 2BR.500 RECT/SU, SAILLIE 500MM	385,00 €	308,00 €	



## MAT

## CROSSE DOUBLE EN ALU B KC



Référence	Désignation	Prix public € H.T.	Prix promo € H.T.	CODE EAN
PETCROSSE-DALU	CROSSE DOUBLE EN ALU B KC, ø60MM, SAILLIE 0.5M, INCLINAISON 5° + OBTURATEUR	168,30 €	134,64 €	

## MAT ACIER GALVA 4M + TIGES



Référence	Désignation	Prix public € H.T.	Prix promo € H.T.	CODE EAN
SIMCEUF04603	MAT ACIER GALVA 4M + TIGES	330,00 €	180,00 €	



# Index n°

## A

ARI1717 .....	53
ARI3056 .....	87
ARI3943 .....	88
ARI4175 .....	71
ARI4715 .....	94
ARI50161 .....	87
ARI50163 .....	86
ARI50164 .....	87
ARI50230 .....	36
ARI50331 .....	11
ARI50333 .....	11
ARI50393 .....	40
ARI50416 .....	86
ARI50429 .....	86
ARI50436 .....	86
ARI50437 .....	86
ARI50448 .....	71
ARI53052 .....	92
ARI53067 .....	97
ARI53068 .....	97
ARI53069 .....	97
ARI53070 .....	97
ARI55243 .....	102
AURENBH21540 .....	5
AURENBH25W40 .....	6
AURENBZE8W .....	56
AURENDE8CX .....	57
AURENRSP32440 .....	8
AURENSTKM240 .....	101
AURENSTKM2BLU .....	101
AURENSTPEU .....	101
AURENTK3536BLK40 .....	25
AURMLSKB12N .....	26
AURMLSKB16A .....	28
AURMLXTS420N .....	25
AURMLXTS430N .....	25
AURMLX TSA11N .....	26
AURMLX TSA21N .....	26
AURMLX TSA35N .....	27
AURMLX TSA36N .....	27
AURMLX TSA38N .....	27
AURMLX TSA39N .....	27
AURMLX TSA41N .....	28

## C

CHAP01654110 .....	132
--------------------	-----

## D

DEP59700102N .....	135
DEP67405800 .....	136

## E

EBE078220 .....	4
EUR2413 .....	55
EUR2414 .....	55
EUR2415 .....	55
EUR2534 .....	55
EUR256524 .....	55
EUR26201 .....	55
EUR26202 .....	55
EUR26810 .....	56

## E

EUR390131 .....	40
EUR391110 .....	40
EUR3916 .....	41
EUR406338 .....	131
EUR42001 .....	100
EUR4212060 .....	113
EUR42551 .....	101
EUR42558 .....	102
EUR425611 .....	100
EUR42711 .....	99
EUR44028 .....	38
EUR453031 .....	8
EUR5003 .....	58
EUR5004 .....	58
EUR7929 .....	100
EUR89903 .....	99
EUR89905 .....	99
EURDRGU10 .....	111
EURDRGU53 .....	111

## G

GEL93019427 .....	126
GEL93024034 .....	121
GEL93030251 .....	120
GEL93030252 .....	120
GEL93030263 .....	118
GEL93030265 .....	118
GEL93038711 .....	127
GEL93040552 .....	125
GEL93044739 .....	127
GEL93047728 .....	122
GEL93047729 .....	122
GEL93052991 .....	118
GEL93059798 .....	123
GEL93061072 .....	126
GEL93063992 .....	120
GEL93063993 .....	120
GEL93064014 .....	120
GEL93064016 .....	121
GEL93064026 .....	121
GEL93064029 .....	121
GEL93064031 .....	121
GEL93066766 .....	56
GEL93066767 .....	56
GEL93067075 .....	127
GEL93067828 .....	125
GEL93068471 .....	121
GEL93068475 .....	124
GEL93073529 .....	6
GEL93073545 .....	6
GEL93073548 .....	6
GEL93073980 .....	15
GEL93074736 .....	122
GEL93078636 .....	119
GEL93078643 .....	119
GEL93078645 .....	119
GEL93078647 .....	119
GEL93081799 .....	122
GEL93081804 .....	123
GEL93082101 .....	34

## G

GEL93082102 .....	34
GEL93082103 .....	34
GEL93082106 .....	34
GEL93090164 .....	17
GEL93092682 .....	121
GEL93100534 .....	56
GEL93101684 .....	34
GEL93104348 .....	121
GEWGWL1924 .....	36
GEWGWL1925 .....	36
GEWGWP2174AD .....	41
GEGWWS3236PC .....	19
GEGWWS3258PC .....	19
GEGWWS4046GS .....	35
GEGWWS4064GS .....	35
GEGWWS4066GS .....	35
GEGWWS4134GS .....	35

## H

HAGEE632 .....	38
HAGEE633 .....	38
HAGEE634 .....	39
HAGEE636 .....	38
HAGEE637 .....	38
HAGEE638 .....	38
HAGEE642 .....	38
HAGEE643 .....	38
HAGEE644 .....	39

## L

LUM195ABR .....	96
LUM195B .....	96
LUM2013 .....	126
LUM3401 .....	128
LUM3607 .....	12
LUM3610 .....	12
LUM3612US42B .....	8
LUM3617 .....	12
LUM362440B .....	8
LUM3625 .....	12
LUM4103 .....	14
LUM4108 .....	14
LUM72015346KBD .....	7
LUM7271442S .....	6
LUM73030346KBD .....	7
LUM7363042S .....	7
LUM861B .....	9
LUM888 .....	41
LUM889 .....	41
LUM897 .....	40
LUM913 .....	40
LUM940 .....	34
LUM941 .....	34
LUM942 .....	34
LUM943 .....	34
LUM963 .....	34
LUM970 .....	36
LUM971 .....	36
LUM972 .....	37
LUM9921 .....	112

## N

NOV107G-G05X1A-0 .....	88
NOV107H-G05X1A-0 .....	88
NOV169A-G05X1A-0 .....	88
NOV169C-G05X1A-0 .....	89
NOV321A-G05X1A-0 .....	89
NOV681A-G05X1A-0 .....	89
NOV684A-G05X1A-0 .....	73
NOV685A-G05X1A-0 .....	74
NOV685B-G05X1A-0 .....	74
NOV720B-G05X1A-5 .....	74
NOV797A-L0121B-92 .....	74
NOV802B-L3360B-01 .....	75

## O

ORB126941 .....	110
-----------------	-----

## P

PET7101485903 .....	136
PETCROSSE-DALU .....	137
PHI069622 .....	15
PHI070079 .....	21
PHI072431 .....	21
PHI072455 .....	21
PHI072691 .....	9
PHI072707 .....	9
PHI073285 .....	13
PHI073308 .....	14
PHI096403 .....	32
PHI112820 .....	32
PHI161436 .....	123
PHI161474 .....	123
PHI161511 .....	123
PHI161559 .....	124
PHI161658 .....	124
PHI306636 .....	10
PHI329710 .....	33
PHI329734 .....	33
PHI329758 .....	33
PHI331294 .....	33
PHI331300 .....	33
PHI331348 .....	33
PHI331362 .....	33
PHI340491116 .....	94
PHI340501116 .....	94
PHI340581116 .....	96
PHI340591116 .....	96
PHI381769 .....	9
PHI381783 .....	9
PHI389123 .....	17
PHI389147 .....	17
PHI455873 .....	32
PHI531704816 .....	84
PHI531724816 .....	84
PHI531903116 .....	85
PHI531923116 .....	85
PHI531943116 .....	85
PHI574157 .....	118
PHI588840 .....	124
PHI596647 .....	129
PHI620866 .....	129
PHI631718 .....	130

# Index n°

## P

PHI631770 .....	130
PHI632012 .....	130
PHI632074 .....	130
PHI632197 .....	130
PHI632258 .....	130
PHI639400 .....	130
PHI639486 .....	130
PHI639646 .....	131
PHI643162 .....	131
PHI643186 .....	131
PHI643896 .....	131
PHI643919 .....	131
PHI690873116 .....	85
PHI690878716 .....	85
PHI707890 .....	125
PHI710154 .....	129
PHI710185 .....	129
PHI713921 .....	128
PHI716422 .....	129
PHI728390 .....	125
PHI791803 .....	13
PHI814536 .....	121
PHI815267 .....	128
PHIBGP253-94 .....	132
PHIBVP650 .....	32

## S

SIFEP20042100005 ..	136
SIFEP20042100020 ..	136
SIFSUPPROJPC .....	134
SIM103-YYY386016 ..	134
SIM284-YYY390013 ..	134
SIMCEUF04603 .....	137
SLV1001348 .....	64
SLV132020 .....	84
SLV132021 .....	84
SLV132024 .....	84
SLV132656 .....	69
SLV133300 .....	70
SLV133660 .....	70
SLV133759 .....	83
SLV133851 .....	69
SLV133921 .....	83
SLV133931 .....	83
SLV146632 .....	77
SLV146701 .....	83
SLV146704 .....	83
SLV147203 .....	68
SLV147213 .....	68
SLV147441 .....	80
SLV147442 .....	80
SLV147443 .....	80
SLV147444 .....	80
SLV148001 .....	81
SLV148004 .....	81
SLV148010 .....	81
SLV148011 .....	82
SLV148018 .....	82
SLV148019 .....	82
SLV149286 .....	68

## S

SLV149701 .....	93
SLV149702 .....	93
SLV149752 .....	95
SLV149782 .....	95
SLV149792 .....	96
SLV151543 .....	93
SLV151553 .....	93
SLV151801 .....	79
SLV151854 .....	70
SLV151884 .....	79
SLV151912 .....	80
SLV151922 .....	80
SLV152810 .....	25
SLV153814 .....	85
SLV155542 .....	65
SLV155551 .....	65
SLV155561 .....	65
SLV155582 .....	60
SLV155583 .....	60
SLV155584 .....	60
SLV155586 .....	60
SLV155592 .....	60
SLV155650 .....	66
SLV155651 .....	66
SLV155652 .....	66
SLV155690 .....	67
SLV155710 .....	67
SLV155712 .....	67
SLV155713 .....	67
SLV155720 .....	68
SLV155723 .....	67
SLV155750 .....	79
SLV155751 .....	79
SLV155770 .....	61
SLV155780 .....	61
SLV155785 .....	62
SLV155790 .....	62
SLV155841 .....	62
SLV155871 .....	63
SLV155930 .....	63
SLV156030 .....	63
SLV156031 .....	63
SLV156113 .....	60
SLV156116 .....	60
SLV156119 .....	60
SLV156122 .....	61
SLV156141 .....	60
SLV156143 .....	60
SLV156146 .....	60
SLV156147 .....	60
SLV156152 .....	60
SLV156301 .....	64
SLV158634 .....	64
SLV175024 .....	28
SLV175044 .....	29
SLV175064 .....	30
SLV175074 .....	29
SLV175170 .....	30
SLV175204 .....	29
SLV229071 .....	78

## S

SLV229270 .....	58
SLV229924 .....	43
SLV229925 .....	43
SLV229927 .....	43
SLV230044 .....	48
SLV230045 .....	48
SLV230655 .....	48
SLV230657 .....	48
SLV231371 .....	42
SLV231385 .....	50
SLV231395 .....	51
SLV231457 .....	51
SLV231855 .....	51
SLV232905 .....	77
SLV233104 .....	78
SLV233105 .....	78
SLV233115 .....	78
SLV233447 .....	42
SMA10.002.89 .....	95
SMA10.009.37 .....	107
SMA10.009.61 .....	109
SMA10.009.62 .....	109
SMA10.010.36 .....	52
SMA10.010.53 .....	45
SMA10.010.67 .....	48
SMA10.011.55 .....	44
SMA10.011.57 .....	44
SMA10.011.58 .....	45
SMA10.020.73 .....	46
SMA10.024.46 .....	53
SMA10.027.31 .....	46
SMA10.030.77 .....	105
SMA10.042.25 .....	50
SMA10.042.28 .....	47
SMA10.042.29 .....	52
SMA10.042.69 .....	45
SMA10.042.70 .....	53
SMA10.042.72 .....	44
SMA10.042.73 .....	44
SMA10.042.74 .....	53
SMA10.042.75 .....	53
SMA10.044.41 .....	71
SMA10.044.43 .....	71
SMA10.045.31 .....	44
SMA10.048.05 .....	49
SMA10.048.06 .....	46
SMA10.048.08 .....	47
SMA10.048.23 .....	43
SMA10.048.24 .....	43
SMA10.048.25 .....	50
SMA10.048.27 .....	49
SMA10.068.51 .....	49
SMA10.100.09 .....	117
SMA10.100.12 .....	117
SMA10.100.14 .....	117
SMA10.100.16 .....	117
SMA10.100.18 .....	117
SMA10.100.22 .....	117
SMA3000.068 .....	93
SMA3000.069 .....	94

## S

SMA3000.074 .....	92
SMA3000.087 .....	92
SMA5000.158 .....	52
SMA5000.389 .....	108
SMA5000.450 .....	47
SMA5000.488 .....	49
SMA5000.701 .....	105
SMA7000.019 .....	111
SMA7000.020 .....	111
SMA7000.047 .....	110
SMA7000.048 .....	110
SMA7000.061 .....	110
SMAGWS-001-DS .....	105
SMAGWS-003-DS .....	105
SMAIDE-60010 .....	72
SMAIDE-60011 .....	72
SMAIDE-60012 .....	73
SMAIDE-60013 .....	72
SMAIDE-60014 .....	72
SMAIDE-60015 .....	72
SMAIDE-60016 .....	72
SMALSO-04011 .....	115
SMALSO-04021 .....	115
SMALSO-04031 .....	115
SMALSO-04051 .....	115
SMALSO-04061 .....	115
SMALSO-04071 .....	116
SMALSO-04081 .....	116
SMALSO-04091 .....	116
SMALSO-04101 .....	116
SMASF-500/3F .....	112
SMASF-500WD/2F ..	112
SMASH5-SET-GW-F ..	111
SOL2012 .....	104
SOL260238I .....	104
SOL260238IN .....	104
SOL260290I .....	104
SOL260290IB .....	104
SOL260290N .....	107
SOL2602MB .....	104
SOL2602MI .....	104
SOL3210W .....	105
SOLB00738B .....	106
SOLB00790I .....	106
SOLCP06N .....	106
SOLHY0005 .....	106
SOLNM01MAT .....	107

## T

TAR1T4055 .....	65
TAR1T4082 .....	64
TAR1T4193 .....	69
TAR1T6090EL .....	77
THE1020702 .....	90
THE1020902 .....	90
THE1020904 .....	90
THE1020906 .....	90
THE1020911 .....	37
THE1020913 .....	37
THE1020915 .....	37

## Index n°

### T

THE1020981 .....	39
THE1020983 .....	39
THO96257119 .....	132
THO96261772 .....	133
THO96262903 .....	133
THO96666080 .....	4
TRFSIM-S5498W19 .	42
TRFSIM-S6250W14 .	42
TRFSIM-S6260W14 .	42
TRI1717610 .....	7
TRI2194700 .....	24
TRI2197300 .....	24
TRI2342800 .....	24
TRI5218904 .....	19
TRI5219504 .....	19
TRI5219804 .....	19
TRI5220404 .....	19
TRI5221004 .....	19
TRI5221304 .....	19
TRI5287304 .....	19
TRI5287504 .....	19
TRI5289504 .....	16
TRI5311000 .....	16
TRI5640304 .....	19
TRI5795204 .....	20
TRI5797204 .....	20
TRI5827504 .....	19
TRI5996510 .....	73
TRI6190904 .....	18
TRI6314604 .....	16
TRI6315004 .....	16
TRI6315104 .....	16
TRI6316804 .....	16
TRI6317240 .....	18
TRI6461340 .....	23
TRI6470500 .....	23
TRI6470800 .....	23
TRI6471900 .....	23
TRI6472540 .....	16
TRI6486240 .....	20
TRI6486340 .....	20
TRI6486440 .....	20
TRI6486540 .....	20
TRI6528740 .....	11
TRI6574840 .....	22
TRI6575040 .....	22
TRI6631640 .....	18
TRI6742940 .....	15
TRI6797440 .....	18
TRI6797640 .....	18
TRI6854640 .....	11
TRI6864740 .....	12
TRI6864940 .....	12
TRI6913740 .....	11
TRI6914840 .....	15
TRI6914851 .....	15
TRI6928940 .....	133
TRI6929040 .....	133
TRI6930300 .....	133
TRI6960040 .....	35

### T

TRI6960140 .....	35
TRI6964340 .....	5
TRI6964740 .....	5
TRI6964840 .....	5
TRI6965140 .....	5
TRI6965240 .....	5
TRI7076640 .....	35
TRI7100000 .....	13
TRI7115640 .....	17
TRI7115840 .....	17
TRI7142840 .....	15
TRI7143040 .....	10
TRI7143140 .....	10
TRI7143240 .....	22
TRI7143340 .....	22
TRI7143440 .....	4
TRI7164440 .....	13
TRI7165040 .....	14
TRI7165051 .....	14
TRI7165440 .....	15
TRI7165740 .....	13

### V

VELIS744 .....	37
----------------	----

### X

XPE40067 .....	108
XPE40068 .....	108
XPE40071 .....	108

# Index

ÉCLAIRAGE D'EXTÉRIEUR À LED .....	50
ÉCLAIRAGE LED DE PLACARD .....	111
ÉCLAIRAGE PUBLIC .....	132
ÉTANCHE LED IP66 5000H COMPLETS .....	18
ÉTANCHES .....	17

## 2

2320 C07 WR LED 20/12/ML-840 E .....	10
2325 C07 OA LED 18/10/ML-840 E .....	10
2380 ARMATURE INDUSTRIELLE .....	22

## A

ABAT-JOUR FENDA 15CM .....	60
ABAT-JOUR FENDA 30 CM et 45 CM .....	60
ACCESSOIRES .....	110
ADAPTATEUR ONTRIA DIAMÈTRE 60 .....	133
ADAPTATEUR TRIPHASÉ POUR RAIL EN SAILLIE TRIPHASÉ 230V ..	29
AIR INDI 22 ROND BLANC .....	83
ALIMENTATION POUR RAIL EN SAILLIE TRIPHASÉ 230V .....	29
AMPOULE LED R7SLED J118 R7SLED .....	126
APPLIQUE DE MIROIR DE SALLE DE BAIN .....	92
APPLIQUE DE MIROIR LED .....	92
APPLIQUE DOMINO S7-P LED 17W/4000K .....	87
APPLIQUE ET PLAFONNIER EXTÉRIEUR TERANG .....	43
APPLIQUE ET PLAFONNIER VAYNISSA LED .....	93
APPLIQUE HAWAI LED 8W/3000K .....	86
APPLIQUE INCLINÉE SOLAIRE AVEC DÉTECTEUR .....	105
APPLIQUE LED .....	93
APPLIQUE LED THELEDA D B PLUS AL - DÉTECTEUR DE MOUVEN	90
APPLIQUE LED THELEDA D UD AL AVEC DÉTECTEUR DE MOUVEN	90
APPLIQUE MIROIR NIKA IP44 A/LPE G9 25W .....	94
APPLIQUE MOOREA LED 8W/3000K .....	87
APPLIQUE MURALE À LED .....	43
APPLIQUE MURALE À LED INTÉGRÉ AVEC CAPTEUR JOUR / NUIT	44
APPLIQUE MURALE AVEC SOCLE .....	44
APPLIQUE MURALE BASTIA .....	44, 45
APPLIQUE MURALE D'EXTÉRIEUR .....	45
APPLIQUE MURALE D'EXTÉRIEUR AVEC DÉTECTEUR .....	46
APPLIQUE MURALE D'EXTÉRIEUR EN MÉTAL .....	46
APPLIQUE MURALE D'EXTÉRIEUR HAUT/BAS GRISE .....	46
APPLIQUE MURALE D'EXTÉRIEUR MODERNE .....	47
APPLIQUE MURALE D'EXTÉRIEUR RONDE .....	47
APPLIQUE MURALE EXTÉRIEURE EN MÉTAL .....	47
APPLIQUE MURALE GLASGOW .....	48
APPLIQUE MURALE HAUT ET BAS .....	49
APPLIQUE MURALE HOTSTONE WALL LAMPE LED CHROME .....	94
APPLIQUE MURALE LED LORNA AVEC/SANS DÉTECTEUR .....	49
APPLIQUE MURALE ORIENTABLE AVEC DÉTECTEUR .....	49
APPLIQUE MURALE RÉTRO EN ALU .....	50
APPLIQUE ORIENTABLE LED .....	95
APPLIQUE SOLAIRE LED .....	105
APPLIQUE TESSA LED .....	92
APPLIQUE TRUKKO MIROIR MURAK IP44 .....	95
APPLIQUE VISSARDO MURAL IP44 .....	95
APPLIQUES ET PLAFONNIERS .....	76, 77
ARMATURE INDUSTRIELLE LED POUR MONTAGE SUSPENDU .....	22
ASTO 1 ALU BROSSE GU10 SPOT .....	80

## B

Back cover .....	146
BARRE LED AVEC INTERRUPTEUR .....	110
BARRO 1 ET 2 ROND .....	80
BOÎTIER TYPE 0 CLASSE II ORNES 2X16 MM <sup>2</sup> .....	136
BOÎTIER TYPE 597 CLASSE II .....	135

## B

BORNE ALU NOIR H800MM .....	106
BORNE BLANCHE H380MM POUR ÉCLAIRAGE ET BALISAGE .....	106
BORNE INOX 380MM .....	104
BORNE LUNA 250 410MM BLC/OPALE .....	53
BULAN BLANCHE E14 .....	78
BVP154 & BVP155 LED PSU .....	33
BVP154 LED PSU VWB C .....	33
BVP650 LTX ECO 29000/NW PSU II .....	32

## C

CADRE SAILLIE SMB W60L60 .....	14
CAPSULE LED G9 827 2,5W .....	126
CLA LEDLUSTER ND 2-25W P45 E27 .....	118
CLEARFLOOD LARGE .....	32
CLIPS DE FIXATION INOX LONGFLEX 15W/M .....	102
CLOCKWORK SINGLE SPOT ALUMINIUM .....	84
COLERETTE ALU CARRÉ FINITION ALU .....	55
COLLERETTE ET MODULE LED CX 220-240V 8W FIXE .....	56
COLLERETTE ÉVASÉE DÉCO ROND BLANC .....	56
COLLERETTES BE BEST 1/4 TOUR ORIENTABLE .....	55
CONNECTEUR LONGITUDINAL POUR RAIL EN SAILLIE TRIPHASÉ :	29
CONNECTEUR MÂLE ET FEMELLE À 7 PÔLES .....	24
CONVERTISSEUR ÉLECTRONIQUE 2X30W IP66 12VDC .....	113
CORDON D'ALIMENTATION POUR RUBAN LED .....	101
CORELINE TEMPO MOYEN ET GRAND .....	32
COREPRO LED STICK ND 9.5-75W T .....	121
COREPRO LEDCAPSULE ND 1.9-25W .....	128
COREPRO LEDCAPSULE ND 3.2-40W .....	128
Cover .....	1, 146
CRAMPON DE SUSPENSION POUR MONTAGE PAR CHAÎNE .....	24
CROSSE DOUBLE EN ALU B KC .....	137
CROSSE EP200 42 1000 .....	136

## D

DALLE LED 36W 6000K V2 .....	14
DALLE LED ENCASTRÉE 600X600 .....	15
DECANTER BLANC GESSO 320 3000 .....	64
DÉTECTEUR D'OBSTACLE .....	110
DEVIN SIMPLE LED CHROME .....	93
DIO FLEX PLUG CHROME/BLANC .....	77
DN060B LED18S/840 PSU WH .....	10
DN065B LED10S/840 PSU II WH .....	9
DOUILLE GU10 TRIPLE BORNIER RAPIDE .....	111
DOUILLE GU5.3 .....	110
DOWNLIGHT ENCASTRÉ LED - AVIELLA C05 OA 1200-840 ET 1 ..	12
DOWNLIGHT LED ORIENTABLE APEX .....	8
DOWNLIGHT LED RECTANGLE INCLINABLE .....	9
DOWNLIGHT LED ROND 4000K .....	8

## E

E14 830 ET 865 LED BRIGHTSTIK 7W .....	122
E27 827 LED GLASS A67 10W(75) .....	122
E27 830 15W PAR38 .....	127
E27 865 LED GLASS A60 8W(60) .....	122
ECOLED BLC 5 5W/4000K .....	86
EMBOUT D'ALIMENTATION GAUCHE .....	26
EMBOUT DE FINITION POUR RAIL T .....	28
EMBOUT FRONTAL IP20 .....	24
EMBOUT MAT D60MM POUR PROJECTEUR .....	41
EMBOUT PIPE DOUBLE .....	136
EMBOUT POUR RAIL EN SAILLIE TRIPHASÉ 230V .....	30
ENCASTRÉ DE SOL .....	105
ENCASTRÉ DE SOL EXTÉRIEUR DASAR .....	58
ENCASTRÉ DE SOL ROND INOX BOUNTY .....	58
ENCATRE LED 600x600 .....	13

# Index

## E

ENOLA_B PD-1 GRIS ARGENT/NOIR .....	70
ENOLA_B UP/DOWN BLANCHE .....	79
EUROSPOT LED GRIS 30W .....	85
EXTÉRIEUR ET JARDIN .....	31, 42

## F

FIL LED G80 827 6.5W .....	118
FILIN DE SUSPENSION POUR RAIL EN SAILLIE TRIPHASÉ 230V ...	30
FIT APPLIQUE MURALE CHROME .....	96
FLAMLED E14G 827 6W .....	120
FLEXE240™ - KIT DE RUBAN LED IP65 INTERCONNECTABLE 240V	101
FONCTIONNEL .....	4

## G

GRACE ENCASTRÉ IP20/44 LED INTÉGRÉ 7W/3000K .....	11
GU10G 830 5,5W LED DIM .....	124

## H

HUBLOT / PLAFONNIER EXTÉRIEUR LED .....	4
HUBLOT AVEC SYSTÈME LED - LIMARO .....	5
HUBLOT LED 4200K IP54 .....	6
HUBLOT LED À DÉTECTEUR 6500K .....	6
HUBLOT LED IP54 .....	7
HUBLOT LED POLYCARBONATE OVALE .....	5
HUBLOT LED POLYCARBONATE ROND .....	6
HUBLOT ROND TOM LED 300 1200 840 WH .....	4
HUBLOTS .....	4

## I

ISARO MA34-42 .....	133
---------------------	-----

## J

JEU D'INTERRUPTEUR INTELLIGENT + TÉLÉCOMMANDE .....	111
---	-----

## K

KALO KR PATERE IP44 A/G9 28W .....	88
KIT 2 PRISES EXTERIOR + TÉLÉCOMMANDE .....	112
KIT 3 PRISES INTERIOR + TÉLÉCOMMANDE .....	112
KIT CONNEXION LONGFLEX 15W/M .....	101
KIT DE 3 SPOTS LED ENCASTRABLE .....	52
KIT ÉTRIER .....	36
KIT FLEXO LED 120 2400K / 2,5M .....	102
KIT SDB IP65 9W850 .....	96

## L

LAMPADAIRE BISHADE SL-1 .....	66
LAMPADAIRE EXTÉRIEUR .....	42
LAMPADAIRE EXTÉRIEUR ADEGAN MANILA .....	51
LAMPADAIRE EXTÉRIEUR BOOKAT .....	51
LAMPADAIRE EXTÉRIEUR SLOTS 65 .....	51
LAMPADAIRE HY005 6 W .....	106
LAMPADAIRE SOPRANA BOW SL-1 E27 .....	67
LAMPADAIRE TENORA FL-1 DIFFUSEUR .....	63
LAMPE 2602-90N .....	107
LAMPE À POSER D'EXTÉRIEUR ADEGAN MANILA .....	50
LAMPE DE BUREAU BISHADE TL-1 .....	66
LAMPE DE BUREAU SOPRANA OVAL .....	62
LAMPE DE JARDIN LED .....	52
LAMPE LED GU10 3W 38 RGBW BLU .....	131
LAMPE SOLAIRE AUTONOME POUR PILLIERS ET POTEAUX .....	104
LAMPES .....	114
LANTERNE SOLAIRE 15W 1600LM .....	108
LED 1,5WE27 B-C STARRY COEUR .....	115
LED 1,5WE27 B-C STARRY ÉTOILE .....	115
LED 1,5WE27 B-C STARRY GLOBE .....	115
LED 3,5W 3D GLOBE E27 .....	116

## L

LED 3,5W 3D ST64 E27 .....	116
LED 3,5W 3D STD E27 .....	116
LED 80W/HID/740/E40 .....	127
LED E14 2,5W B-C OR .....	117
LED E27 2,5W B-C OR .....	117
LED E27 827 10W A60 .....	120
LED FIL HELIAX CANDLE 3.5W .....	119
LED FIL HELIAX GLOBE .....	119
LED FIL HELIAX PEAR 5.5W .....	119
LED GLASS A67 13W(100) 865 E27 .....	123
LED GLASS E27 840 8W A60 .....	123
LED GU10 865 5W LED 35° .....	125
LED MARINER ST G1 TU 2' 24W 865 S EU .....	17
LED SPOT À ENCASTRER .....	56
LED SSW 60W A60 E27 WW-CW FR N .....	124
LEDINAIRE WT060C ÉTANCHE .....	17
LEDSTICK E27 830 ET 865 .....	120
LED'UP ÉCO SLIM ROND .....	8
LES ENCASTRÉS .....	8, 54
LES ENCASTRÉS DE SOL .....	58
LES ENCASTRÉS DÉCO .....	55
LIGNES LUMINEUSES .....	23
LINOLITE LED10W 800LM 840 .....	128
LIPSY 50 M COLOR CONTROL .....	83
LONGFLEX 4000K 510LM/M 230V - 10W/M .....	100
LPE GU10 4,6W 840 36° .....	125
LU6NM01MAT - MAT LAMPADAIRE NM .....	107
LUMINAIRE ÉTANCHE À LED - NEXTREMA .....	18
LUMINAIRE SUSPENDU À RÉFLECTEUR PC PRISMATIQUE .....	73
LUMINAIRE TECHNIQUE À PLAQUE DE RECouvreMENT - ONTRI	133
LUMINAIRES FONCTIONNELS .....	13
LUMINAIRES TUBULAIRES AU DIAMÈTRE EXTÉRIEUR .....	18
LUMISTREET MEDIUM BGP253 ECO94/740 II DM 48/60S .....	132
LUXÈTRE PORTABLE .....	132

## M

MAS LED SPOT VLE D 4.9-50W GU1 .....	125
MASTER PL-C 13W/827/2P 1CT/5X .....	129
MASTER TL5 HE 14W/840 1SL/20 .....	130
MASTER TL5 HE 28W/865 SLV/40 .....	129
MASTER TL5 HO 54W/840 SLV/20 .....	131
MASTER TL-D SUPER 80 18W/840 .....	130
MASTERCOLOUR CDM-E MW ECO 230W .....	129
MAT .....	136
MAT ACIER GALVA 4M + TIGES .....	137
MERCURY LED E27 740 35W .....	127
MERIDIAN BOX E27 .....	48
METRIC WALL LAMP WHITE 2X2W SEL .....	85
MILLENNIUM SPOT WHITE .....	85
MINILEAR .....	42
MINISKILL .....	42
MIROIR À POSER VISSARDO .....	96
MYRA UP/DOWN ANTHRACITE .....	78
MYRA WALL .....	78
MZD LED 40W A60 E27 840 FR ND .....	123

## N

NATH LANTERNE EP 81W 3000K .....	134
NELLA 100W E27 .....	132

## O

ORDI ANTHRACITE .....	77
-----------------------	----

## P

PACK BE GOOD 1-5X1M DIFF/CLIPS/ .....	99
---------------------------------------	----

# Index

## P

PACK PROFIL SLIDE R AL 5X1M .....	99
PACK S/SOFT 3M 4000K 5W/M .....	100
PACK SUPER SOFT PRO 4000K 5M .....	99
PANNEAU LEDINAIRE LED .....	13
PANTHEON LED SUSPENSION 400MM 10W .....	65
PIED DE LAMPADAIRE FENDA .....	62
PIED DE LAMPE DE BUREAU FENDA .....	61
PIED DE LAMPE FENDA BETON .....	67
PIED DE LAMPE FENDA CHROMÉ 40W .....	65
PIED DE LAMPE FENDA MÉTAL BROSSÉ .....	62
PIPOFLEX .....	83
PIQUETS PROJECTEUR .....	41
PISCINE LED PAR56 16W (300) 7 .....	126
PLAFOND BRITTA IP20 .....	89
PLAFOND FAR IP44 .....	88
PLAFOND KIRA IP54 .....	89
PLAFOND KIRA IP54 E27 .....	88
PLAFOND TORNADO IP54 .....	89
PLAFONNIER / APPLIQUE MURALE OPALE RONDE .....	4
PLAFONNIER C4 BLANC 10W/4000K IP44 .....	86
PLAFONNIER ET APPLIQUE MURALE POUR APPLICATION STAND .....	19
PLAFONNIER ET SUSPENSION FENDA PATERE .....	65
PLAFONNIER ÉTANCHE AVEC LED MID POWER .....	19
PLAFONNIER ÉTANCHE ROND AVEC VASQUE PC OPALE CULOT E .....	7
PLAFONNIER POUR LOCAUX HUMIDES ET EXTÉRIEUR SOUS ABR .....	17
PLAFONNIER/APPLIQUE D'EXTÉRIEUR DUBLIN .....	52
PLAFONNIERS À LAMPES FLUORESCENTES .....	16
PLAFONNIERS À LED .....	15
PLAQUE DE RECOUVREMENT À MONTAGE RAPIDE C-LINE LED .....	23
PLASTRA 100 SLOT PLATRE BLANC .....	81
PLASTRA 103 T5 PLATRE BLANC .....	82
PLASTRA 105 E27 PLATRE BLANC .....	81
PLASTRA CL-1 CARRÉ PLATRE .....	81
PLASTRA CUBE PLATRE BLANC G9 .....	82
PLASTRA SQUARE PLATRE BLANC .....	82
PLATINE-APPAREILLAGE LED POUR SYSTÈME DE LIGNE CONTINU .....	23
POTEAUX DE JARDIN EXTÉRIEUR .....	53
POTELET DE JARDIN LED INTÉGRÉ .....	53
PROFITS - SUPPORTS POUR L'ÉCLAIRAGE INDUSTRIEL .....	23
PROJECTEUR ALUMINIUM LED TRIPH .....	25
PROJECTEUR DÉTECTEUR LED 20W - 30W - 50W .....	36
PROJECTEUR DTC 102-180 10W BLANC .....	37
PROJECTEUR ELFI BLC 60 10W/4000K .....	36
PROJECTEUR LED - LUMINIS .....	34
PROJECTEUR LED 20000LM .....	41
PROJECTEUR LED POUR ILLUMINATION ET ÉCLAIRAGE DE SURFA .....	35
PROJECTEUR LED RECHARGEABLE .....	40
PROJECTEUR LED RGB 20W PADLIGHT .....	37
PROJECTEUR LED SOLAIRE .....	108
PROJECTEUR LED SPOT AVEC DÉTECTEUR DE MOUVEMENT .....	39
PROJECTEUR ZODIAK LED 10W/4000K IP65 .....	40
PROJECTEURS .....	32
PROJECTEURS LED - GÉNÉRAL ÉLECTRIC .....	34
PROJECTEURS LED - HAGER .....	38
PROJECTEURS LED HAUTE PUISSANCE .....	35

## R

RÉGLETTE PENTURA MINI LED .....	21
RACCORD DROIT POUR RAIL TRIPHASÉ .....	26
RACCORD EN L (EXTÉRIEUR) .....	27
RACCORD EN T (EXTÉRIEUR DROIT ET GAUCHE) .....	27
RACCORD EN X POUR RAIL TRIPHASÉ .....	27
RAIL D'ÉCLAIRAGE TRIPHASÉ SAIL .....	25
RAIL EN SAILLIE TROIS ALLUMAGES 230V 2M .....	28
RAILS .....	25

## R

RÉGLETTE LED TALASSO LED .....	97
RÉGLETTE LEDINAIRE BN060C .....	21
RÉGLETTES À MONTAGE APPARENT POUR 1 LAMPE FLUORENSC .....	20
RÉGLETTES À MONTAGE APPRENT LED .....	20
ROCHER SOLAIRE NAXOS .....	107
RS061B LED5-36-/840 PSR II WH .....	9
RUBAN LED .....	99
RUBANS LEDS .....	98

## S

SALLE DE BAIN .....	91, 92
SIELLA II M73 OTA LED3200-840 .....	13
SKAT LANTERNE EP 32W WDL .....	134
SLIM WALL LED WALL U/D LED 24W .....	69
SMART 20-60VA - IP 68 - CÂBLE ENTRÉE / SORTIE .....	100
SNCPOINT 905 C02 BR-FL LED1100 .....	11
SOLAIRE .....	103, 104
SOPRANA SOLID WL-1 E14 .....	79
SOURCES .....	115
SPHÈRE LED EG 827 6W .....	118
SPOT 79 230V GU10 .....	84
SPOT DE SOL SOLAIRE ROND .....	108
SPOT ENCASTRÉ - AMBIELLA G2 C07 HR LED2000-840 .....	11
SPOT ROND À ENCATRER ROND .....	12
SPOT SOLAIRE ENCASTRABLE CARLO CARRÉ .....	109
SPOT SOLAIRE ENCASTRABLE CARLO ROND .....	109
SPOT SUPROS POUR RAIL TRIPHASÉ .....	25
SUPPORT DE FIXATION NOIR POUR RAIL .....	26
SUPPORT DE PROJECTEUR .....	134
SUPPORT DE SUSPENSION ALUMINIUM .....	28
SUSPENSION BAGUET IP20 .....	74
SUSPENSION BISHADE PD-1 3X E27 .....	66
SUSPENSION CIMENT BRUT .....	72
SUSPENSION CUSKA IP20 .....	74
SUSPENSION ELGA IP20 .....	73
SUSPENSION FITU E27 RONDE ALU .....	69
SUSPENSION FORCHINI M PD-1 .....	63
SUSPENSION GHO LED 60W 3187LM .....	75
SUSPENSION I-RING BLANC .....	64
SUSPENSION LED E27 .....	71
SUSPENSION LED PANEL ROND .....	64
SUSPENSION LIÈGE .....	72
SUSPENSION MALANG LED .....	68
SUSPENSION MEDO 90 RING .....	69
SUSPENSION MEDO LED ALU .....	68
SUSPENSION MÉTAL .....	72
SUSPENSION NAE LED 21W 1700LM .....	74
SUSPENSION ORION E14 .....	70
SUSPENSION PHELIA RONDE .....	70
SUSPENSION PLATE CUIVRE/NOIR .....	71
SUSPENSION RONDE CUIVRE/NOIR .....	71
SUSPENSION SOPRANA CONE PD-2 .....	61
SUSPENSION SOPRANA SOLID .....	67
SUSPENSION TRIADEM .....	63
SUSPENSIONS INDUSTRIELLES .....	22
SUSPENSIONS, LAMPADAIRES ET LAMPES À POSER .....	59, 60

## T

THREESIXTY 23W 384 U/D OPAL 3 .....	77
TRANSFORMATEUR ÉLECTRONIQUE DIMMABLE LED & HALOGÈNE .....	112

## Y

YAH PROJECTEURS SUR PIQUET .....	40
YAKO PERF RGBW 20W NR .....	38



# Index

## Z

ZENIT 30 GRIS SMD LED 6W ..... 79





RUE JOSEPH CUGNOT  
Z.I. DE JARRY  
97122 BAIE-MAHAULT

---

LIEU-DIT LES PÈRES BLANCS  
97123 BAILLIF

